

Clinical Study Protocol
Drug Substance Budesonide/ Formoterol Fumarate (BFF)
Study Code D5980C00023
Version 4.0
Date 10 August 2020

AstraZeneca

Clinical Study Protocol

Drug Substance	Budesonide/ Formoterol Fumarate (BFF) MDI
Study Code	D5980C00023
Version	4.0
Date	10 August 2020

A Randomized, Open-Label, Two Period Crossover, Chronic Dosing, 1-Week, Pilot Study to Assess the Efficacy and Safety of Budesonide and Formoterol Fumarate Inhalation Aerosol Administered with a Spacer Compared with Symbicort® Turbuhaler® in Subjects with Severe to Very Severe Chronic Obstructive Pulmonary Disease and Low Peak Inspiratory Flow

Sponsor: AstraZeneca AB, 151 85 Södertälje, Sweden

Regulatory Agency Identifying Number(s): IND 118313; EudraCT 2019-001801-26

VERSION HISTORY

Version 1.0, ^{CCI}
Initial creation
Version 2.0, ^{CCI} (1 st Amended Protocol)
Section 5.1 Inclusion Criteria #14 Reproduction: <ul style="list-style-type: none">Revised criteria #14 for contraception to include the following acceptable methods of contraception based on latest guidance:<p>“Female subjects must be 1 year post-menopausal, surgically sterile, or using an acceptable method of contraception (an acceptable method of contraception is defined as a barrier method in conjunction with a spermicide) for the duration of the study (from the time they sign consent) to prevent pregnancy. In addition, oral contraceptives, approved contraceptive implant, long-term injectable contraception, intrauterine device, or tubal ligation are allowed. Oral contraception alone is not acceptable; additional barrier methods in conjunction with spermicide must be used.”</p>
Section 5.2 Exclusion Criteria #3 Medical Conditions and #14 Prior Concomitant Therapy: <ul style="list-style-type: none">Included additional conditions in criteria #3 such as thyrotoxicosis, phaeochromocytoma, untreated hypokalaemia, and fungal infections in the airways that may qualify for significant disease exclusions. which, in the opinion of the Investigator, may either put the subject at risk because of participation in the study, or influence the results of the study.Revised prior concomitant therapy and related time periods that apply during screening and randomized treatment periods in criteria #14:<p>“Unable to abstain from protocol-defined prohibited medications (see Section 6.5.2) within the time period specified in Table 6 prior to and during Screening and Randomized Treatment periods”</p>
Section 7.1 Discontinuation of Study Treatment: <ul style="list-style-type: none">Clarify criteria for Adverse event to include examples of paradoxical bronchospasm, severe allergic reaction.
Section 7.4 Study and Site Closure: <ul style="list-style-type: none">Content for this topic added per revised protocol guidance

Appendix E: Subject Instructions for Use of BFF MDI and Budesonide MDI:

- Revised the section on the use of the inhaler to include Step 9 to rinse mouth after dosing

Version 3.0, ^{CCI} (2nd Amended Protocol)

General changes:

- Population definition changed from “moderate to very severe” to “severe to very severe” to align with changed inclusion and randomization criteria.
- InCheck device setting changed from “Turbuhaler resistance” to “Turbuhaler S resistance” (which stands for “Turbuhaler Symbicort” as per InCheck device manual) throughout the protocol for clarification, because there are two different Turbuhaler resistance settings on the InCheck device.

Table 1 Schedule of Activities:

- Correction of week timeframes to be consistent with day timeframes for Screening Visit (“-3 to -1” instead of “-3 to -2”) and for Run-in visit (“-1” instead of “-2”).
- “X” added for AE Assessment at Screening visit and footnote “t” added to clarify the start of reporting timeframes for non-serious and serious adverse events.
- “X” added at Screening for Training and demonstration of proper device and spacer use including priming for adequate training of proper device and spacer use.

Synopsis:

- Principal Investigator function revised to International Coordinating Investigator.
- **Synopsis: Number of Subjects and Section 4.1 Overall design:** Approximate number of prospective subjects to be screened has been changed from “45” to “150” to accommodate high screen failure rate anticipated for the study.
- Revised wording to clarify that study will be conducted in “approximately 4 sites”.
- Randomization stratification revised from setting “no resistance” to “Turbuhaler S resistance” and changed limit for PIF from “<45 L/min versus ≥ 45 to <60 L/min” to “<40 L/min versus ≥ 40 ”.
- Respective revisions to align with the above changes added throughout the protocol.

Section 1.3 Schema:

- Revised Figure 1. Removed footnote stating possibility to combine Visit 1 and Visit 2, as this statement was not correct. Corrected week for Visit 2 from “-2” to “-1”

Section 4.1 Overall design:

- Revised wording to clarify that both screening and washout medications Berodual and Budesonide (if applicable) should be stopped in the clinic after the evening dose prior to study visit the next day.

Section 5.1 Inclusion criteria and Section 5.3 Randomization Criteria:

Rationale for change: To allow the study to enrol an eligible population with PIF of <50L/min, recruitment will be limited to patients with severe to very severe COPD. This should reduce screen failure rate and support enrolment of the appropriate study population. The following eligibility criteria are revised in the following sections and throughout the protocol as appropriate:

- Inclusion criterion 7: revised to require post-bronchodilator FEV₁ of <50% instead of <80% predicted normal value at Visit 2.
- Inclusion criterion 8: revised InCheck device setting from “no resistance” to “Turbuhaler S resistance” and lowered PIF limit from “<60 L/min” to “<50 L/min” at Visit 2.
- Randomization criterion 1: revised to require FEV₁ of <50% instead of <80% predicted normal value.
- Randomization criterion 2: revised InCheck device setting from “no resistance” to “Turbuhaler S resistance” and lowered PIF limit from “<60 L/min” to “<50 L/min”.

Section 5.2 Exclusion Criteria:

- Criterion #22 clarified to state randomization instead of enrolment.

Section 5.4.1 Caffeine and Tobacco:

- Revised and softened restrictions to refrain from smoking “until after the last spirometry assessment” instead of “throughout the duration of each study visit”.

Section 5.5 Screen Failures

- Section revised to align with and allow rescreening based on revised inclusion and randomization criteria: “Subjects who did not meet PIF inclusion or randomization criterion with InCheck set for no resistance as per previous CSP version 2.0 can be also re-screened.”

Section 6 Study Treatments

- Clarification that InCheck devices are first presented to subjects at Visit 1 for training.

Section 6.2 Preparation/Handling/Storage/Accountability:

- Wording of storage requirements for Symbicort Turbuhaler, Budesonide MDI, BFF MDI and Berodual revised for consistency with drug labels and appendices at the end of CSP.
- Added storage requirements for Ventolin.

Section 6.3 Measures to Minimise Bias: Randomization and Blinding:

- Revised to clarify the use of the IWRS system that it will be used to assign drug only and not be used to manage the distribution of clinical supplies. Study personnel will have access to an IWRS to allocate subjects and to assign drug to subjects.

Section 8.3.2 Time Period and Frequency for Collecting AE and SAE Information:

- Section revised to clarify reporting timeframes for non-serious and serious adverse events.

Section 9.3 Populations for Analyses:

- Revised naming of protocol deviations to “important” instead of “major” to align with Statistical Analysis Plan and current AstraZeneca nomenclature.
- Revised wording for clarification.

Section 9.4.2 Pharmacokinetic Analyses and Appendix M Abbreviations:

- PK parameter C_{trough} was added in Section 9.4.2 and to abbreviation list in order to align with the Statistical Analysis Plan.

Appendix B Regulatory, Ethical and Study Oversight Considerations:

- Added subsection B 2 Regulatory Reporting Requirements for SAEs to clarify regulatory reporting requirements for SAEs.

Appendix A Instruction for Use of InCheck Inspiratory Flow Measurement Device:

- Added InCheck instruction pages describing resistance settings for different type of inhalers to clarify resistance settings referenced in this protocol.
-

Version 4.0, 10 August 2020 (3rd Amended Protocol)

Most revisions in this amendment address the impact of study hold and re-start during the COVID-19 pandemic and related local advisories.

Section 1.1 Schedule of Activities (SoA)

- Footnote ‘t’ was updated to include details for adverse event assessments related to COVID-19 before subject attending the clinic visit and at study clinic visits during the study treatment period.
- Footnote ‘u’ added to provide details for medical history assessments related to COVID-19 before subject attending the clinic visit and at study clinic visits prior to randomization

Section 1.2 Synopsis

- International Coordinating Investigator updated
- Overall design section updated to include details on subject disposition adjustment to ensure safety of subjects during any unforeseen circumstances.

- Estimated date of last subject completed updated
- Under Statistical methods section, updates made to the ITT, mITT, and Safety Population description to include description of data will be handled for patients affected by COVID-19 related study hold

Section 2.3.1 COVID-19 Impact Assessment

- New sub-section 2.3.1 added to provide an assessment of risk with investigational product during COVID-19 pandemic.

Section 4.1 Overall Design

- Updated section for additional clarity

Section 4.1.1 Study Conduct Mitigation During Study Disruption Due to Cases of Civil Crisis, Natural Disaster, or Public Health Crisis

- New sub-section 4.1.1 added to provide guidance for study conduct during unforeseen events e.g. civil crisis, natural disaster, or public health crisis
- Additional sub-section 4.1.1.1 added to provide details on the subject disposition due to unforeseen circumstances.

Section 5.2 Exclusion Criteria

- Exclusion criteria 19, and 22 revised to include details for COVID-19 related assessment(s)

Section 5.5 Screen Failures and Subjects affected by Study or Site Hold

- Section title updated to “Subjects affected by Study or Site Hold”
- Updated section 5.5.1 to include all conditions for rescreening of subjects in the study.
- Added Section 5.5.2 titled “Subjects Affected by Study or Site Hold” to include details for re-inviting subjects that were screen failed or discontinued due to study being placed on hold.

Section 6.1.1 Investigational Products (Table 3)

- Asterix added to clarify treatment as Investigational Product.

Section 6.3 Measure to Minimise Bias: Randomization and Blinding

- Updated section to include details on the use of new subject identifiers and randomization codes for subjects that were screen failed or discontinued due to COVID-19.

Section 6.5.2.1 Prohibited COPD Medications (Table 5)

- Footnote a, b, and c updated to clarify and include budesonide (where applicable) and berodual and ventolin washout periods

Section 7.1 Discontinuation of Treatment and Subject Withdrawal

- Added criteria for discontinuation due to exclusion criteria

Section 9.3 Populations for Analyses

- Updates made to the ITT, mITT, and Safety Population description to include an explanation on how patients who were discontinued due to the study being put on hold for COVID-19 related concerns will be handled in the analyses.

Section 9.4.3.2 Analysis of Secondary Efficacy Variable

- Statement added under Supportive Analyses regarding additional sensitivity that will be carried out to assess the impact of COVID-19.

Appendix M

- Appendix added to provide study instructions for mitigations due to civil crisis, natural disaster, or public health crisis.

Appendix N

- Abbreviations moved from Appendix M to Appendix N

This Clinical Study Protocol has been subject to a peer review according to AstraZeneca Standard procedures. The Clinical Study Protocol is publicly registered and the results are disclosed and/or published according to the AstraZeneca Global Policy on Bioethics and in compliance with prevailing laws and regulations.

TABLE OF CONTENTS

TITLE PAGE	1
VERSION HISTORY	2
TABLE OF CONTENTS	8
1. PROTOCOL SUMMARY	12
1.1 Schedule of Activities (SoA)	12
1.2 Synopsis.....	17
1.3 Schema	23
2. INTRODUCTION	24
2.1 Study Rationale.....	24
2.2 Background.....	25
2.3 Benefit/Risk Assessment	25
2.3.1 COVID-19 Impact Assessment	26
3. OBJECTIVES AND ENDPOINTS	26
4. STUDY DESIGN.....	27
4.1 Overall Design	27
4.1.1 Study Conduct Mitigation During Study Disruption Due to Cases of Civil Crisis, Natural Disaster, or Public Health Crisis	29
4.1.1.1 Subject Disposition	29
4.2 Scientific Rationale for Study Design.....	30
4.3 Justification for Dose	30
4.4 End of Study Definition	31
5. STUDY POPULATION.....	31
5.1 Inclusion Criteria.....	31
5.2 Exclusion Criteria	32
5.3 Randomization Criteria	35
5.4 Lifestyle Restrictions.....	35
5.4.1 Caffeine and Tobacco.....	35
5.4.2 Illicit Drugs or Drugs of Abuse	35
5.5 Screen Failures and Subjects affected by Study or Site Hold	35
5.5.1 Rescreening Subjects.....	36
5.5.2 Subjects Affected By Study or Site Hold.....	36
6. STUDY TREATMENTS	36

6.1	Treatments Administered	37
6.1.1	Investigational Products	37
6.2	Preparation/Handling/Storage/Accountability.....	37
6.3	Measures to Minimise Bias: Randomization and Blinding	39
6.4	Treatment Compliance	40
6.5	Concomitant Therapy	40
6.5.1	Allowed Medications	40
6.5.2	Prohibited Medications.....	41
6.5.2.1	Prohibited COPD Medications	41
6.5.2.2	Prohibited Non-COPD and Non-Respiratory Medications and Washout Periods	42
6.5.3	Other Concomitant Treatment	44
6.6	Dose modification	44
6.7	Treatment After the End of the Study	44
7.	DISCONTINUATION OF TREATMENT AND SUBJECT WITHDRAWAL...	44
7.1	Discontinuation of Study Treatment	44
7.1.1	Procedures for Discontinuation of Study Treatment.....	44
7.2	Lost to Follow-Up.....	45
7.3	Withdrawal From the Study	45
7.4	Study and Site Closure	45
8.	STUDY ASSESSMENTS AND PROCEDURES.....	46
8.1	Efficacy Assessments.....	47
8.1.1	Pulmonary Function Tests.....	47
8.1.2	Peak Inspiratory Flow	48
8.1.3	Inspiratory Capacity	48
8.1.4	Chronic Obstructive Pulmonary Disease Assessment Test (CAT).....	48
8.2	Safety Assessments	49
8.2.1	Clinical Laboratory Assessments.....	49
8.2.2	Physical Examinations and Other Screening Assessments	49
8.3	Collection of Adverse Events	50
8.3.1	Method of Detecting AEs and SAEs.....	50
8.3.2	Time Period and Frequency for Collecting AE and SAE Information	50
8.3.3	Follow-Up of AEs and SAEs.....	50
8.3.4	Adverse Event Data Collection.....	51
8.3.5	Causality Collection	51
8.3.6	Adverse Events Based on Signs and Symptoms.....	52
8.4	Safety Reporting and Medical Management	52

8.4.1	Reporting of Serious Adverse Events	52
8.4.2	Pregnancy	52
8.4.2.1	Maternal Exposure	53
8.4.3	Overdose.....	53
8.4.4	Medication Error.....	54
8.5	Pharmacokinetics	54
8.5.1	Procedure for Blood Sample Collection and Schedule	54
8.5.2	Determination of Drug Concentration.....	54
8.5.3	Storage and Destruction of PK Samples	55
8.6	Pharmacodynamics	55
8.7	Genetics	55
8.8	Biomarkers.....	55
8.9	Medical Resource Utilization and Health Economics	55
9.	STATISTICAL CONSIDERATIONS	55
9.1	Statistical Hypotheses	55
9.2	Sample Size Determination	55
9.3	Populations for Analyses.....	56
9.4	Statistical Analyses	57
9.4.1	Baseline for Analyses.....	58
9.4.2	Visit Windows	58
9.4.3	Efficacy Analyses	58
9.4.3.1	Primary Efficacy Analysis.....	58
9.4.3.2	Analysis of Secondary Efficacy Variables	58
9.4.3.3	Estimand.....	60
9.4.1	Safety Analyses.....	60
9.4.2	Pharmacokinetic Analyses.....	60
9.4.3	Methods for Multiplicity Control.....	61
9.5	Interim analyses	61
10.	REFERENCES	62
11.	SUPPORTING DOCUMENTATION AND OPERATIONAL CONSIDERATIONS	63

LIST OF TABLES

Table 1	Schedule of Assessments.....	13
Table 2	Study Objectives	26

Table 3	Study Treatments	37
Table 4	Allowed COPD and Allergy Medications	41
Table 5	COPD Medications Prohibited Beginning at Visit 1 and Required Washout Period Prior to Visit 2	42
Table 6	Prohibited Non-COPD and Non-Respiratory Medications	43
Table 7	Laboratory Safety Variables	49

LIST OF FIGURES

Figure 1	Study design.....	23
----------	-------------------	----

LIST OF APPENDICES

Appendix A	Instructions for Use of Berodual Respimat	64
Appendix B	Regulatory, Ethical and Study Oversight Considerations	69
Appendix C	Instructions for Use of Ventolin HFA.....	73
Appendix D	Dose Indicator Display Reading Instructions	81
Appendix E	Subject Instructions for Use of BFF MDI and Budesonide MDI	82
Appendix F	Instructions for Use of Symbicort Turbuhaler Inhalation Powder Device.....	91
Appendix G	Instructions for Use of AeroChamber PlusFlow Vu	93
Appendix H	Spirometry Performance Recommendations	94
Appendix I	Spirometry Assessment Criteria	100
Appendix J	Instruction for Use of InCheck Inspiratory Flow Measurement Device.....	102
Appendix K	COPD Assessment Test.....	109
Appendix L	Adverse Event Definitions and Additional Safety Information.....	110
Appendix M	Study Instructions for Mitigation Due to Civil Crisis, Natural Disaster, or Public Health Crisis.....	114
Appendix N	Abbreviations	116

1. PROTOCOL SUMMARY

1.1 Schedule of Activities (SoA)

Table 1 Schedule of Assessments

	Screening	Run-in	Treatment Periods and Washout				D/C	Follow-up Call	Details in CSP Section and/or Appendix
			Treatment 1		Treatment 2		D/C	7 to 14 days post-last dose	
	Visit ^a	1	2	3	4	5			
Week	-3 to -1	-1	Rand	1	3	4			
Day	-21 to -7	-7 ± 3	1	8 ± 1	22 ± 1	29 ± 1			
Informed consent	X							Section 5.1, Appendix B 4	
Inclusion /exclusion criteria	X	X	X					Section 5.1 and Section 5.2	
Randomization criteria			X					Section 5.3	
Routine clinical procedures									
Demography and medical ^u /surgical history	X							Section 8.2.2	
Physical examination	X							Section 8.2.2	
Smoking status	X							Section 8.2.2	
CAT score		X						Section 8.1.4 and Appendix K	
Prior/concomitant medication review ^b	X	X	X	X	X	X	X	X	Section 6.5
Vital signs ^c	X								Section 8.2.2
12-lead ECG ^c	X								Section 8.2.2
COPD exacerbation history	X	X	X						Section 8.2.2
Urine pregnancy testing ^d	X								Section 5.1
Clinical laboratory testing ^c	X								Section 8.2.1
Discontinue COPD maintenance therapy	X								Section 4.1
Start Berodual/budesonide MDI	X ^e			X ^f					Section 4.1
Discontinue Berodual/budesonide MDI			X ^g		X ^g				Section 4.1
Start Randomized treatment			X ^h		X ^h				Section 4.1
Discontinue Randomized treatment				X ⁱ		X ⁱ			Section 4.1

	Screening	Run-in	Treatment Periods and Washout				D/C	Follow-up Call	Details in CSP Section and/or Appendix
			Treatment 1	Treatment 2			D/C	7 to 14 days post-last dose	
Visit ^a	1	2	3	4	5	6			
Week	-3 to -1	-1	Rand	1	3	4			
Day	-21 to -7	-7 ± 3	1	8 ± 1	22 ± 1	29 ± 1			
Routine safety measurements									
AE assessments ^t	X	X	X	X	X	X	X	X	Section 8.3 and Appendix L
Efficacy measurements									
Reversibility		X ^j							Section 8.1.1
Spirometry (FEV ₁ , FVC)		X	X ^k	X ^l	X ^k	X ^l	X ^m		Section 8.1.1
Pre-dose peak inspiratory flow ⁿ (PIF)		X	X	X	X	X			Section 8.1.2
IC			X ^o	X ^p	X ^o	X ^p			Section 8.1.3
PK profile ^q				X		X			Section 8.5
Study treatment administration									
Training and demonstration of proper device and spacer use including priming	X	X	X	X	X	X			Section 6.2, Appendix A, Appendix D, Appendix E, Appendix F, and Appendix F
PIF training	X	X	X	X	X	X			Section 8.1.2 and Appendix J
Study treatment dispensed and collected	X	X	X	X	X	X	X		Section 6.2
Rescue medication dispensed and collected	X	X	X	X	X	X	X		Section 6
Review of paper diaries and dose indicators		X	X	X	X	X	X		Section 6.4
IP administration ^s			X ^r	X ^r	X ^r	X ^r			Section 6.2

	Screening	Run-in	Treatment Periods and Washout				D/C	Follow-up Call	Details in CSP Section and/or Appendix
			Treatment 1		Treatment 2		D/C	7 to 14 days post-last dose	
Visit ^a	1	2	3	4	5	6			
Week	-3 to -1	-1	Rand	1	3	4			
Day	-21 to -7	-7 ± 3	1	8 ± 1	22 ± 1	29 ± 1			
<p>Abbreviations: CAT=COPD Assessment Test; COPD=Chronic Obstructive Pulmonary Disease; CSP=Clinical Study Protocol; D/C=discontinuation; ECG=electrocardiogram; eCRF=electronic case report form; FEV₁=forced expiratory flow in 1 second; FVC=forced vital capacity; IC=inspiratory capacity; IP=investigational product; PIF=peak inspiratory flow; PK=pharmacokinetics; Rand=randomization</p> <p>a. Sites should make every effort to maintain subjects within the scheduled visit window. Subjects who fall outside the visit window will be placed in the appropriate visit window at the next scheduled visit.</p> <p>b. At all visits, note time of last dose and short-acting bronchodilator and other COPD medications; if less than approximately 6 hours prior to lung function assessments, the visit should be rescheduled.</p> <p>c. Assessed for screening purposes only.</p> <p>d. Pregnancy testing to be performed for women of childbearing potential.</p> <p>e. Budesonide (if applicable) and Berodual to be started after the morning visit at Visit 1.</p> <p>f. Budesonide (if applicable) and Berodual to be started the evening of Visit 4.</p> <p>g. Budesonide (if applicable) and Berodual will be stopped the evening prior to Visits 3 and 5.</p> <p>h. Randomized treatment will begin the morning of Visit 3 and Visit 5.</p> <p>i. The last dose of randomized treatment will be given the morning of Visit 4 and Visit 6 in the clinic.</p> <p>j. Spirometry to be performed approximately 45 minutes pre-bronchodilator and 30 to 60 minutes post-bronchodilator and reversibility calculated to characterize the subject population.</p> <p>k. At Visits 3 and 5 (Day 1 of each Treatment Period), spirometry will be performed at specific timepoints (approximately 45 minutes pre-dose and 2 hours post-dose).</p> <p>l. At Visits 4 and 6 (Day 8 of each Treatment Period), spirometry will be performed at specific timepoints (approximately 45 minutes pre-dose and 30 minutes and 1, 2, and 4 hours post-dose).</p> <p>m. Spirometry to be performed at the Early Discontinuation/Withdrawal Visit only if subject is still taking IP (last dose of IP on day before or at visit).</p> <p>n. PIF to be performed pre-dose using the InCheck Inspiratory Flow Measurement Device set to no resistance and then repeated with resistance equal to Turbuhaler S and then equal to ELLIPTA.</p> <p>o. At Visits 3 and 5 (Day 1 of each Treatment Period), IC will be conducted approximately 45 minutes pre-dose and 2 hours post-dose. IC assessments should be performed prior to spirometry assessments.</p> <p>p. At Visits 4 and 6 (Day 8 of each Treatment Period), IC will be conducted 2 hours post-dose. IC assessments should be performed prior to spirometry assessments.</p> <p>q. PK samples to be collected in the morning of Visit 4 and Visit 6 within 30 minutes prior to dosing and 2, 5, 20, 30, and 40 minutes and 1, 2, 3, and 4 hours post-dose. If spirometry and PK assessments are to be performed at the same timepoint, PK samples should be drawn first followed by spirometry measurements.</p>									

	Screening	Run-in	Treatment Periods and Washout				D/C	Follow-up Call	Details in CSP Section and/or Appendix
			Treatment 1		Treatment 2		D/C	7 to 14 days post-last dose	
Visit ^a	1	2	3	4	5	6			
Week	-3 to -1	-1	Rand	1	3	4			
Day	-21 to -7	-7 ± 3	1	8 ± 1	22 ± 1	29 ± 1			
<p>r. Subjects will be admitted to the clinic on the day before Visits 3, 4, 5, and 6.</p> <p>s. Starting at Visit 3, IP should be taken at the same times every day. In-clinic dosing time is recorded as time of the second puff/inhalation. The time of dosing needs to be monitored and the time of morning dosing on visit days should be standardized to be no less than 11 hours and no more than 12 hours from the previous evening dose at Visit 4 and Visit 6.</p> <p>t. Non-serious adverse events will be collected from Randomization throughout the Treatment Period and including the washout and follow-up periods. Serious adverse events will be recorded from the time of signing of informed consent form. Risk assessments for the evaluation of any safety events including for COVID-19 should be made prior to and at every in-clinic visit during treatment in-line with Protocol Section 4.1.1.1 and COVID-19 guidance (See Study Procedures Manual).</p> <p>u. In addition to medical history, a COVID assessment should be made prior to subject coming into clinic and at every in-clinic visit in-line with Protocol section 4.1.1.1 and COVID guidance (see Study Procedure manual). Prior to visit 1, site should follow local health guidelines to assess for COVID-19.</p>									

1.2 Synopsis

International Coordinating Investigator

PPD

82131 Gauting
Germany

Protocol Title: A Randomized, Open-Label, Two Period Crossover, Chronic Dosing, 1-Week, Pilot Study to Assess the Efficacy and Safety of Budesonide and Formoterol Fumarate Inhalation Aerosol Administered with a Spacer Compared with Symbicort® Turbuhaler® in Subjects with Severe to Very Severe Chronic Obstructive Pulmonary Disease and Low Peak Inspiratory Flow

Short Title: PT010 Re-admission Pilot

Rationale: Patients who have chronic obstructive pulmonary disease (COPD) with low peak inspiratory flow (PIF) may be at risk of suboptimal delivery to the airways of orally inhaled medications, in particular, those devices with high inspiratory air flow resistance [Loh, 2017; Mahler, 2017]. Sharma et al has hypothesized that ineffective inhalation of medications due to low PIF can result in poor COPD management and adverse consequences for the patient [Sharma, 2017]. Inhalation devices differ with respect to airflow resistance with metered dose inhalers (MDIs) posing essentially no resistance to airflow and dry powder inhalers (DPIs) having resistances which vary by device type [Altman, 2018]. The hypothesis of interest for this study is whether lung function outcomes in patients with COPD and low PIF (defined as <50 L/min) would be influenced by delivering maintenance medication via an MDI versus a DPI.

In order to improve coordination of inhaler actuation and inspiration, a valved holding chamber (or spacer) may be used with an MDI. A spacer may also reduce the amount of drug that is deposited in the oropharynx.

The goal of this study is to assess the efficacy and safety of Budesonide and Formoterol Fumarate Inhalation Aerosol (hereafter referred to as BFF MDI) administered with a spacer compared with budesonide/formoterol fumarate DPI (hereafter referred to as Symbicort® Turbuhaler®) over a 1-week treatment period in a crossover fashion in subjects with COPD and a low PIF. The primary efficacy outcome is lung function following 1 week of treatment. The outcome of this study will further inform on the design and sample size of future studies investigating this concept.

Objectives and Endpoints

Primary Objective:	Endpoint/Variable:
To assess the effects of BFF MDI administered with a spacer relative to Symbicort Turbuhaler on lung function, measured by peak forced expiratory volume in 1 second (FEV ₁) within 4 hours post-dose at Week 1, in subjects with COPD and low PIF.	<ul style="list-style-type: none">• Peak change from baseline in FEV₁ within 4 hours post-dose following 1 week of treatment
Secondary Objective:	Endpoint/Variable:
To assess the effects of BFF MDI administered with a spacer relative to Symbicort Turbuhaler on additional measures of lung function.	<ul style="list-style-type: none">• Area under the curve for change from baseline in FEV₁ from 0 to 4 hours (AUC_{0-4 h}) following 1 week of treatment• Change from baseline in pre-dose FEV₁ following 1 week of treatment• Change from baseline in 2-hour post-dose inspiratory capacity (IC) following 1 week of treatment• Change from baseline in pre-dose PIF (InCheck Device set to no resistance, resistance set equal to Turbuhaler S, and resistance set equal to ELLIPTA) following 1 week of treatment• Change from baseline in 2-hour post-dose FEV₁ following the first dose• Change from baseline in 2-hour post-dose IC following the first dose
Safety Objective:	Endpoint/Variable:
To assess the safety of BFF MDI administered with a spacer and Symbicort Turbuhaler	<ul style="list-style-type: none">• AEs• Serious adverse events (SAEs)• Adverse events leading to treatment discontinuation

Pharmacokinetic Objective:

To characterize the steady state pharmacokinetics (PK) of budesonide and formoterol from drug administration of BFF MDI administered with a spacer and Symbicort Turbuhaler

Endpoint/Variable:

The endpoints following 1 week of treatment are:

1. Steady state area under the concentration-time curve from time 0 to 4-hours post-dose (AUC_{0-4})
 - Time to maximum observed peak concentration (t_{max})
 - Maximum observed plasma concentration (C_{max})
-

Overall design:

This is a Phase IIIb randomized, open-label, 2 period (each 1-week treatment) crossover efficacy and safety pilot study comparing BFF MDI 320/9.6 μ g administered with a spacer twice daily (BID) with Symbicort Turbuhaler 320/9 μ g BID in subjects with severe to very severe COPD and low PIF.

Following randomization, subjects will undergo 2 treatment periods of 1 week each, with an intervening two-week washout period where they will use Berodual and budesonide MDI 320 μ g BID (budesonide to only be used for subjects receiving ICS therapy at screening). Subjects will be admitted to the clinic on the day before Visits 3, 4, 5, and 6. The time of dosing needs to be monitored and the time of morning dosing on visit days needs to be standardized.

Subject disposition could be adjusted to ensure safety of the subjects during the study due to unforeseen circumstances by the study sponsor for e.g. a pandemic, local health advisory, travel related restrictions, etc.

This study will be conducted at approximately 4 sites.

Study Period:

Estimated date of first subject enrolled Q3 2019

Estimated date of last subject completed Q1 2021

Number of Subjects:

It is planned that approximately 150 prospective subjects will be screened, with approximately 30 subjects randomized, 15 per sequence, in order to ensure at least 26 subjects completing the study.

Randomization will be stratified by the Visit 3 PIF set to Turbuhaler S resistance (<40 L/min versus \geq 40 L/min).

Treatments and treatment duration:

All eligible subjects must be taking 2 or more inhaled maintenance therapies including at least 1 long-acting bronchodilator for the management of their COPD for at least 4 weeks prior to Visit 1. At Visit 1, subjects will discontinue their COPD maintenance therapies and will enter a 2- to 3-week run-in period on Berodual 20/50 µg QID and budesonide MDI 320 µg BID (budesonide to only be used for subjects receiving ICS therapy at screening). Albuterol/salbutamol sulfate (for the purpose of this protocol referred to as Ventolin HFA) will be provided to use as rescue medication throughout the study.

At Visit 2, subjects must demonstrate a post-bronchodilator FEV₁/forced vital capacity (FVC) of <0.70, a post-bronchodilator FEV₁ of <50% predicted normal value, and PIF of <50 L/min using the InCheck Inspiratory Flow Measurement Device set to Turbuhaler S resistance. Additionally, subjects will have PIF measured at Visit 2 with the InCheck Device set to no resistance and then equal to the ELLIPTA resistance. Reversibility and COPD Assessment Test (CAT) will also be captured at Visit 2 in order to characterize the patient population.

At Visit 3, following the 2- to 3-week run-in period, subjects who demonstrate a pre-dose FEV₁/FVC of <0.70, an FEV₁ of <50% predicted normal value, and a PIF of <50 L/min using the InCheck Inspiratory Flow Measurement Device set to Turbuhaler S resistance will discontinue treatment with Berodual and budesonide MDI 320 µg BID (budesonide to only be used for subjects receiving ICS therapy at screening) and be randomized in a 1:1 scheme to either open-label BFF MDI 320/9.6 µg administered with a spacer BID or open-label Symbicort Turbuhaler 320/9 µg BID. At Visit 4, subjects will discontinue their randomized treatment from Period 1 and begin treatment with Berodual and budesonide MDI (if applicable) for a 2-week wash-out period. At Visit 5, subjects will discontinue treatment with Berodual and budesonide MDI (if applicable) and will begin randomized treatment for Period 2 of the crossover. Pre- and post-dose spirometry assessments will be conducted at Visits 3 through 6.

Statistical methods

A total of approximately 30 subjects, 15 per sequence, (with at least 26 subjects completing the study) are planned to be randomized in this study. The sample size has been selected based on practical considerations to obtain reasonable estimates for the primary and secondary objectives of this study, which will be used to further inform on the design and sample size needed for future studies.

For purposes of analyses, the following populations are defined:

Population	Description
Enrolled	All subjects who sign the ICF.
Intent-to-Treat (ITT) Population	<p>All subjects who are randomized to treatment and receive at least one dose of study treatment. Subjects will be analyzed according to the treatment they were assigned to as randomized, regardless of the treatment actually received.</p> <p>Subjects affected by the study being put on hold for the COVID-19 pandemic will be handled as follows:</p> <ul style="list-style-type: none"> • Subjects who were discontinued due to the study being put on hold and who restarted the study will only be included in the ITT analysis set for the instance of enrolment after they restarted. • Discontinued subjects who do not restart will be included in the ITT analysis set. <p>This ensures that all randomized subjects are included in the ITT set once and once only.</p>
Modified ITT (mITT) Population	<p>All subjects in the ITT Population with post-baseline spirometry data from both treatment periods at Visits 4 and 6. Data judged to be impacted by major protocol violations will be excluded. Subjects will be analyzed according to the treatment they were assigned to as randomized.</p> <p>Subjects affected by the study being put on hold for the COVID-19 pandemic will be handled as follows:</p> <ul style="list-style-type: none"> • Subjects who were discontinued due to the study being put on hold and who restarted the study will only be included in the mITT analysis set for the instance of enrolment after they restarted, if they have post-baseline spirometry data for both treatment periods after restart and meet the definition described above. • Discontinued subjects who do not restart will not be included in the mITT analysis set as they will not have post-baseline spirometry data from both treatment periods. <p>This ensures that all randomized subjects are included in the mITT set at most once, if they meet the relevant definition.</p>
Safety Population	<p>All subjects who are randomized to treatment and receive at least one dose of the study treatment. Subjects will be analyzed according to the treatment actually received.</p> <p>Subjects affected by the study being put on hold for the COVID-19 pandemic will be handled as follows:</p>

	<ul style="list-style-type: none"> Subjects who were discontinued due to the study being put on hold and who restarted the study will only be included in the Safety analysis set for the instance of enrolment after they restarted. Discontinued subjects who do not restart will be included in the Safety analysis set. <p>This ensures that all randomized subjects are included in the Safety set once and once only.</p>
PK Population	All subjects in the mITT population with C_{max} defined in both treatment periods. Subjects will be analyzed according to the treatment actually received.

Demographics and other baseline characteristics will be summarized only using the ITT and mITT Populations. The mITT Population will be used to summarize the primary and secondary efficacy variables. The ITT Population will be used for sensitivity analyses for the primary endpoint. The Safety Population will be used to summarize safety data. Pharmacokinetic Population will be used to summarize the PK analyses.

Peak change from baseline in FEV₁ within 4 hours post-dose is defined as the maximum of the FEV₁ assessments within 4 hours post-dosing at each visit minus baseline, provided that there are at least 2 non-missing values during the first 4 hours post-dose.

The peak change from baseline in FEV₁ will be analyzed using an analysis of covariance model with baseline FEV₁, PIF at screening and reversibility to Ventolin HFA as continuous covariates and treatment, and period as categorical covariates. The model will include subject as a random effect to model correlation within subject across the study. The model will not include treatment sequence unless that term is determined to be important ($p < 0.10$). 95% confidence intervals will be produced. P-values will be produced to aid interpretation although these will not be inferential.

1.3 Schema

The general study design is summarized in [Figure 1](#).

Figure 1 Study design

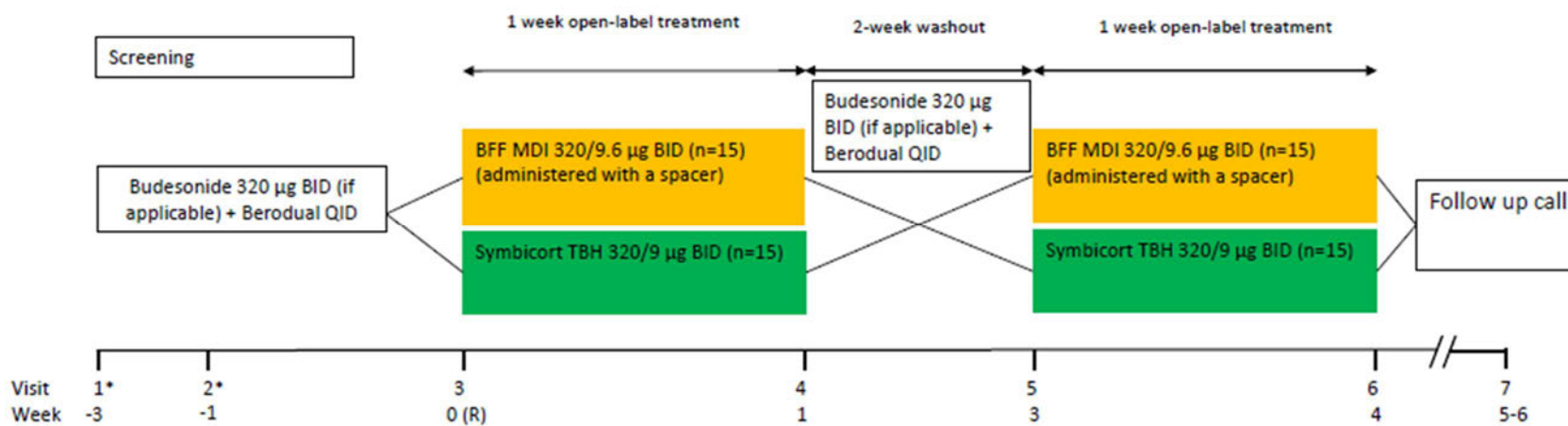

BFF – Budesonide/Formoterol
 BID – Twice Daily Dosing
 MDI – Metered dose inhaler
 QID – Four Times a Day
 TBH – Turbuhaler

2. INTRODUCTION

The Sponsor is developing a family of orally inhaled drug products containing budesonide, glycopyrronium, and/or formoterol fumarate as dual and triple combination products for the treatment of COPD. These drug products are metered dose inhalers (MDIs) formulated as a suspension with micronized active pharmaceutical ingredients and Co-Suspension™ Delivery Technology. The Co-Suspension Delivery Technology consists of spray-dried porous particles comprised of the phospholipid 1,2-distearoyl-sn-glycero-3-phosphocholine and calcium chloride suspended in a hydrofluoroalkane (HFA) propellant. When used in combination MDI products, these particles form strong non-specific associations with the active pharmaceutical ingredients, preventing the drugs from interacting with each other in the suspension and providing reproducible drug delivery and long-term stability.

The test formulation to be evaluated in this study is an MDI containing a combination of budesonide, an inhaled corticosteroid (ICS) and formoterol fumarate, a long-acting β_2 -agonist (LABA).

2.1 Study Rationale

Patients who have chronic obstructive pulmonary disease (COPD) with low peak inspiratory flow (PIF) may be at risk of suboptimal delivery to the airways of orally inhaled medications, in particular, those devices with high inspiratory air flow resistance [Loh, 2017; Mahler, 2017]. Sharma et al has hypothesized that ineffective inhalation of medications due to low PIF can result in poor COPD management and adverse consequences for the patient [Sharma, 2017]. Inhalation devices differ with respect to airflow resistance with MDIs posing essentially no resistance to airflow and dry powder inhalers (DPIs) having resistances which vary by device type [Altman, 2018]. The hypothesis of interest for this study is whether lung function outcomes in patients with COPD and low PIF (defined as <50 L/min) would be influenced by delivering maintenance medication via an MDI versus a DPI.

In order to improve coordination of inhaler actuation and inspiration, a valved holding chamber (or spacer) may be used with an MDI. A spacer may also reduce the amount of drug that is deposited in the oropharynx.

The goal of this study is to assess the efficacy and safety of Budesonide and Formoterol Fumarate Inhalation Aerosol (hereafter referred to as BFF MDI) administered with a spacer compared with budesonide/formoterol fumarate DPI (hereafter referred to as Symbicort® Turbuhaler®) over a 1-week treatment period in a crossover fashion in subjects with COPD and a low PIF. The primary efficacy outcome is lung function following 1 week of treatment. The outcome of this study will further inform on the design and sample size of future studies investigating this concept.

2.2 Background

Chronic obstructive pulmonary disease is a common preventable and treatable disease characterized by persistent airflow limitation that is usually progressive and associated with an enhanced chronic inflammatory response in the airways and the lung to noxious particles or gases. Exacerbations and co-morbidities contribute to the overall severity in individual patients. Chronic obstructive pulmonary disease is a leading cause of morbidity and mortality worldwide and results in significant economic and social burden that is both substantial and increasing. Pharmacologic therapy in COPD is used to reduce symptoms, reduce the frequency and severity of exacerbations, and improve health status and exercise tolerance as described in the Global Initiative for Chronic Obstructive Lung Disease (GOLD) [GOLD, 2018].

Bronchodilator medications are central to the management of COPD. The principal bronchodilator treatments are β_2 -agonists, anticholinergics, and methylxanthines used as monotherapy or in combination. Treatment with long-acting bronchodilators is more convenient and more effective at producing maintained symptom relief than treatment with short-acting bronchodilators.

Regular treatment with ICS improves symptoms, lung function, and quality of life and reduces the frequency of exacerbations in subjects with COPD. Withdrawal from treatment of ICS may lead to exacerbations in some patients. When combined with a LABA, an ICS is more effective than the individual components in improving lung function, quality of life, and reducing exacerbations in subjects with moderate to very severe COPD [GOLD, 2018].

A detailed description of the chemistry, pharmacology, efficacy, and safety of BFF MDI is provided in the Investigator's Brochure and of Symbicort Turbuhaler is provided in the package insert.

2.3 Benefit/Risk Assessment

In order to evaluate the clinical benefit/risk balance, Phase I and Phase III data with budesonide and formoterol fumarate have been considered.

Budesonide and formoterol fumarate have been well tolerated with a favorable safety profile identified in studies to date [Ferguson, 2018]. Potential risks with BFF MDI will be mitigated by selected inclusion/exclusion criteria, discontinuation criteria, and continuous monitoring of safety data during the study.

The combination of budesonide and formoterol fumarate has a favorable safety profile and is available worldwide in different formulations for both asthma and COPD. The addition of Symbicort Turbuhaler to this study allows for the comparison of the differences in the effectiveness of drug delivery when the combination of budesonide/formoterol fumarate is delivered by an MDI (BFF MDI administered with a spacer) versus a DPI (Symbicort Turbuhaler) and how these differences effect lung function improvements in subjects with COPD and low PIF.

During the run-in and washout periods, subjects will be treated with ipratropium bromide and fenoterol hydrobromide Respimat® 20/50 µg (hereafter referred to as Berodual®) four times a day (QID) and budesonide MDI 320 µg BID (budesonide to only be used for subjects receiving ICS therapy at screening). If additional sites are added to the study and Berodual is not available to those sites, Combivent 20/100 µg will be provided. Instructions for use of Berodual and budesonide MDI are provided in [Appendix A](#) and [Appendix E](#), respectively.

More detailed information about the known and expected benefits and risks and reasonably expected adverse events (AEs) of BFF MDI may be found in the Investigator's Brochure.

2.3.1 COVID-19 Impact Assessment

Neither the mechanisms of action nor available evidence suggest treatments with inhaled Budesonide, Glycopyrronium, and Formoterol Fumarate are associated with increased susceptibility to viral infections. There is currently no available data regarding the risk of SARS-CoV-2 infection/COVID-19 in patients treated with either dual ICS-LABA (Budesonide-Formoterol Fumarate) or triple ICS-LAMA-LABA (Budesonide-Glycopyrronium-Formoterol Fumarate) therapies for COPD or on the severity or progression of disease should a patient treated with either dual ICS-LABA (Budesonide-Formoterol Fumarate) or triple ICS-LAMA-LABA (Budesonide-Glycopyrronium-Formoterol Fumarate) therapies become exposed or infected with SARS-CoV-2.

3. OBJECTIVES AND ENDPOINTS

Table 2 Study Objectives

Primary Objective:	Endpoint/Variable:
To assess the effects of BFF MDI administered with a spacer relative to Symbicort Turbuhaler on lung function, measured by peak forced expiratory volume in 1 second (FEV ₁) within 4 hours post-dose at Week 1, in subjects with COPD and low PIF.	<ul style="list-style-type: none">• Peak change from baseline in FEV₁ within 4 hours post-dose following 1 week of treatment
Secondary Objective:	Endpoint/Variable:
To assess the effects of BFF MDI administered with a spacer relative to Symbicort Turbuhaler on additional measures of lung function.	<ul style="list-style-type: none">• Area under the curve for change from baseline in FEV₁ from 0 to 4 hours (AUC_{0-4 h}) following 1 week of treatment• Change from baseline in pre-dose FEV₁ following 1 week of treatment

- Change from baseline in 2-hour post-dose inspiratory capacity (IC) following 1 week of treatment
- Change from baseline in pre-dose PIF (InCheck Device set to no resistance, resistance set equal to Turbuhaler S, and resistance set equal to ELLIPTA) following 1 week of treatment
- Change from baseline in 2-hour post-dose FEV₁ following the first dose
- Change from baseline in 2-hour post-dose IC following the first dose

Safety Objective:	Endpoint/Variable:
To assess the safety of BFF MDI administered with a spacer and Symbicort Turbuhaler	<ul style="list-style-type: none">• AEs• Serious adverse events (SAEs)• Adverse events leading to treatment discontinuation
Pharmacokinetic Objective:	Endpoint/Variable:
To characterize the steady state pharmacokinetics (PK) of budesonide and formoterol from drug administration of BFF MDI administered with a spacer and Symbicort Turbuhaler	<p>The endpoints following 1 week of treatment are:</p> <ul style="list-style-type: none">• Steady state area under the concentration-time curve from 0 to 4-hours post-dose (AUC₀₋₄)• Time to maximum observed peak concentration (t_{max})• Maximum observed plasma concentration (C_{max})

4. STUDY DESIGN

4.1 Overall Design

This is a Phase IIIb randomized, open-label, 2 period (each 1-week treatment) crossover efficacy and safety pilot study comparing BFF MDI 320/9.6 µg administered with a spacer twice daily (BID) with Symbicort Turbuhaler 320/9 µg BID in subjects with severe to very severe COPD and low PIF. For an overview of the study design see [Figure 1](#). For details on treatments given during the study, see Section [6.1 Treatments Administered](#).

This study will be conducted at approximately 4 sites. It is planned that approximately 150 prospective subjects will be screened, with approximately 30 subjects randomized, 15 per sequence, in order to ensure at least 26 subjects completing the study.

At Visit 1, subjects will sign an informed consent form (ICF). All eligible subjects must be taking 2 or more inhaled maintenance therapies including at least 1 long-acting bronchodilator for the management of their COPD for at least 4 weeks prior to Visit 1. At Visit 1, subjects will discontinue their COPD maintenance therapies and will enter a 2- to 3-week run-in period on Berodual 20/50 µg QID and budesonide MDI 320 µg BID (budesonide to only be used for subjects receiving ICS therapy at screening). Albuterol/salbutamol sulfate (for the purpose of this protocol referred to as Ventolin HFA) will be provided to use as rescue medication throughout the study.

At Visit 2, subjects must demonstrate a post-bronchodilator FEV₁/forced vital capacity (FVC) of <0.70, a post-bronchodilator FEV₁ of <50% predicted normal value, and PIF of <50 L/min using the InCheck Inspiratory Flow Measurement Device set to Turbuhaler S resistance. Additionally, subjects will have PIF measured at Visit 2 with the InCheck Device set to no resistance and then equal to the ELLIPTA resistance. Reversibility and COPD Assessment Test (CAT) will also be captured at Visit 2 in order to characterize the patient population.

At Visit 3, following the 2- to 3-week run-in period, subjects who demonstrate a pre-dose FEV₁/FVC of <0.70, an FEV₁ of <50% predicted normal value, and a PIF of <50 L/min using the InCheck Inspiratory Flow Measurement Device set to Turbuhaler S resistance will discontinue treatment with Berodual and budesonide MDI 320 µg BID (budesonide to only be used for subjects receiving ICS therapy at screening) and be randomized in a 1:1 scheme to either open-label BFF MDI 320/9.6 µg administered with a spacer BID or open-label Symbicort Turbuhaler 320/9 µg BID. At Visit 4, subjects will discontinue their randomized treatment from Period 1 and begin treatment with Berodual and budesonide MDI (if applicable) for a 2-week wash-out period. At Visit 5, subjects will discontinue treatment with Berodual and budesonide MDI (if applicable) and will begin randomized treatment for Period 2 of the crossover.

Randomization will be stratified by the Visit 3 PIF set to Turbuhaler S resistance (<40 L/min versus ≥40 L/min).

Following randomization, subjects will undergo 2 treatment periods of 1 week each, with an intervening two-week washout period where they will use Berodual and budesonide MDI 320 µg BID (budesonide to only be used for subjects receiving ICS therapy at screening). Subjects will be admitted to the clinic prior to evening doses of study treatment on the day before Visits 3, 4, 5, and 6. The time of dosing needs to be monitored and the time of morning dosing on visit days should be standardized to be no less than 11 hours and no more than 12 hours from the previous evening dose at Visit 4 and Visit 6. In order to minimize diurnal variance, sites should make every effort to assess subjects at the same time throughout the study and to discuss the importance of dosing in a timely manner every 12 hours. Dosing for all subjects should be completed by 10 AM.

Berodual and Budesonide (if used by the subject) should be withheld in the clinic after taking and recording the evening dose in the diary on the day prior to the study visit. This will ensure that these medications have been withheld for at least 12 hours prior to the time of spirometry on the following day at the study visit in the clinic. Also, rescue medication (Ventolin) can be used as needed as long as it is withheld at least 6 hours prior to spirometry on study visit day.

Pre- and post-dose spirometry assessments will be conducted at Visits 3 through 6.

4.1.1 Study Conduct Mitigation During Study Disruption Due to Cases of Civil Crisis, Natural Disaster, or Public Health Crisis

This guidance given below supersedes instructions provided elsewhere in this CSP and should be implemented only during cases of civil crisis, natural disaster, or public health (e.g. during quarantines and resulting site closures, regional travel restrictions, and considerations if site personnel or study participants become infected with SARS-CoV-2 or similar pandemic infection) which would prevent or place on hold the conduct of study related activities at study sites, thereby compromising the study site staff or the participants ability to conduct the study. The investigator or designee should contact the study sponsor to discuss whether the mitigation plans below should be implemented.

To ensure continuity of the clinical study during crisis, natural disaster, or public health crisis, changes may be implemented to ensure the safety of study participants, maintain compliance with Good Clinical Practice, and minimize risks to study integrity.

Where allowable by local health authorities, ethics committees, healthcare provider guidelines (e.g. hospital policies) or local government, these changes may include the following options:

Obtaining consent/reconsent for the mitigation procedures (note, in the case of verbal consent/reconsent, the informed consent form (ICF) should be signed at the participant's next contact with the study site). Prior to informed consent form, local study institution or HA guidelines should be followed as appropriate.

4.1.1.1 Subject Disposition

This global study may be re-initiated or conducted during the COVID-19 pandemic, another civil crisis, natural disaster, or public health crisis, and the region and/or country level risk to sites and participants may vary during the conduct of the study. Guidance will be ratified where possible with local regulation, health authority and/or other relevant professional bodies to minimize the expected direct risks to site personnel and study participants. Alternative measures and procedures may be implemented during the conduct of the study and a few examples of impact on subject disposition are presented below.

A subject could be screen failed, also be asked to discontinue IP or be withdrawn from the study due to unforeseen circumstances e.g, subject showing signs/symptoms of or positive for COVID infection, COVID-19 pandemic related local health advisory restrictions, etc. Due to the global pandemic, and keeping in mind the safety of study subjects and study integrity, a decision could

be taken to put the study or site on hold. During the hold, subject disposition may vary for example, e.g. study subjects in run-in could be considered screen failed, or randomized subjects could be discontinued from IP etc. To ensure subject safety during the hold all communications with study subjects could occur via telephone while assuring adequate follow-up. Both screened and randomized subjects who discontinued could be followed up at 7-14 days via telephone to assess their status.

For further details on the study conduct during civil crisis, natural disaster, or public health crisis, refer to [Appendix M](#)

4.2 Scientific Rationale for Study Design

This study will assess the efficacy and safety of BFF MDI 320/9.6 µg administered with a spacer in subjects with COPD who have a low PIF defined as <50 L/min. The product tested in this study, BFF MDI administered with a spacer, is being compared with Symbicort Turbuhaler (an approved ICS/LABA). The study is open-label.

Patients who have COPD with low PIF may be at risk of suboptimal delivery to the airways of orally inhaled medications, in particular, those devices with high inspiratory air flow resistance [[Loh, 2017](#); [Mahler, 2017](#)]. Inhalation devices differ with respect to airflow resistance with MDIs posing essentially no resistance to airflow and DPIs having resistances which vary by device type [[Altman, 2018](#)]. The hypothesis of interest for this study is whether lung function outcomes in patients with COPD and low PIF would be influenced by delivering the budesonide/formoterol fumarate combination via an MDI with a spacer versus a DPI.

Symbicort Turbuhaler has been selected as the comparator to BFF MDI as it is an approved ICS/LABA delivered via a DPI to provide the appropriate comparison between delivery devices. The study is open-label in order to simplify study design for a study of two drugs delivered from different device types. The lung function endpoints are objective measures not expected to be impacted by the open-label nature of the comparison. The 1-week treatment length in this study will be sufficient to reach steady state exposure and to evaluate resulting increases in peak FEV₁ within 4 hours post-dose.

Efficacy will be evaluated with the endpoints of peak change from baseline in FEV₁ within 4 hours post-dose, FEV₁ AUC_{0-4 h} and change from baseline in pre-dose FEV₁, 2-hour post-dose IC, and pre-dose PIF.

4.3 Justification for Dose

Data from Phase I and Phase III studies indicate that budesonide at a dose of 320 µg BID and formoterol at a dose of 9.6 µg BID are appropriate doses to investigate in this study of subjects with COPD. The dose of Symbicort Turbuhaler (320/9 µg BID) used in this study as an active comparator is the approved marketed dose for patients with COPD.

4.4 End of Study Definition

The end of study is defined as the last expected visit/contact of the last subject undergoing the study.

A subject is considered to have completed the study when he/she has completed his/her last scheduled procedure as well as the follow-up telephone call as shown in the SoA ([Table 1](#)).

See [Appendix B 7](#) for guidelines for the dissemination of study results.

5. STUDY POPULATION

Prospective approval of protocol deviations to recruitment and enrollment criteria, also known as protocol waivers or exemptions, is not permitted.

Each subject should meet all of the inclusion criteria, none of the exclusion criteria, and all of the randomization criteria for this study in order to be randomized to a study intervention. Under no circumstances can there be exceptions to this rule. Subjects who do not meet the entry requirements are screen failures, refer to [Section 5.5](#).

In this protocol, “enrolled” subjects are defined as those who sign informed consent. “Randomized” subjects are defined as those who undergo randomization and receive a randomization number.

For procedures for withdrawal of incorrectly randomized subjects see [Section 7.3](#).

5.1 Inclusion Criteria

Informed consent

1. Capable of giving signed informed consent which includes compliance with the requirements and restrictions listed in the ICF and in this protocol at Visit 1.
The ICF process is described in [Appendix B 4](#).

Age

2. Subject must be 40 to 80 years of age inclusive, at the time of signing the ICF.

Type of subject and disease characteristics

3. Individuals who have a physician diagnosis of COPD as defined by the American Thoracic Society (ATS)/European Respiratory Society (ERS) [[Celli, 2004](#)].
4. Require COPD maintenance therapy: all subjects must be receiving 2 or more inhaled maintenance therapies, including at least 1 long-acting bronchodilator, for the management of their COPD for at least 4 weeks prior to Visit 1.

Note: Short-acting β_2 -agonist (SABA) and/or short-acting muscarinic antagonist (SAMA) may be added but will not count towards fulfilling Inclusion criterion #4.

5. Demonstrate acceptable MDI and DPI administration technique.
6. Demonstrate the ability to correctly perform the PIF measurement.
7. A post-bronchodilator FEV₁/FVC of <0.70 and post-bronchodilator FEV₁ of <50% predicted normal value at Visit 2.
8. A pre-bronchodilator PIF of <50 L/min using the InCheck Inspiratory Flow Measurement Device set to Turbuhaler S resistance at Visit 2.
9. Current or former smokers with a history of at least 10 pack-years of cigarette smoking (1 pack year = 20 cigarettes smoked per day for 1 year).
10. Willing and, in the opinion of the Investigator, able to adjust current COPD therapy, as required by the protocol.
11. Compliance: willing to remain at study center as required per protocol to complete all visit assessments.

Sex

12. Male and/or female

Reproduction

13. Negative urine pregnancy test for female subjects of childbearing potential.
14. Female subjects must be 1 year post-menopausal, surgically sterile, or using an acceptable method of contraception (an acceptable method of contraception is defined as a barrier method in conjunction with a spermicide) for the duration of the study (from the time they sign consent) to prevent pregnancy. In addition, oral contraceptives, approved contraceptive implant, long-term injectable contraception, intrauterine device, or tubal ligation are allowed. Oral contraception alone is not acceptable; additional barrier methods in conjunction with spermicide must be used.

5.2 Exclusion Criteria

Medical conditions

1. Current diagnosis of asthma, in the opinion of the Investigator.
2. COPD due to α_1 -Antitrypsin Deficiency.
3. Any significant disease or disorder (e.g., gastrointestinal, liver, renal, neurological, musculoskeletal, endocrine, metabolic, malignant, psychiatric including any conditions such as thyrotoxicosis, pheochromocytoma, untreated hypokalaemia, and fungal infections in the airways) which, in the opinion of the Investigator, may either put the

subject at risk because of participation in the study, or influence the results of the study.

4. Sleep apnea that, in the opinion of the Investigator, is uncontrolled.
5. Other respiratory disorders including known active tuberculosis, lung cancer, cystic fibrosis, significant bronchiectasis (high resolution CT evidence of bronchiectasis that causes repeated acute exacerbations), immune deficiency disorders, severe neurological disorders affecting control of the upper airway, sarcoidosis, idiopathic interstitial pulmonary fibrosis, primary pulmonary hypertension, or pulmonary thromboembolic disease.

Note: Allergic rhinitis is not exclusionary.

6. A moderate or severe exacerbation of COPD within 6 weeks prior to randomization (Visit 3).

Note: The end date of an exacerbation is the last day of treatment with systemic corticosteroids or antibiotics.

7. Pulmonary resection or lung volume reduction surgery during the 6 months prior to Visit 1 (i.e., lobectomy, bronchoscopic lung volume reduction [endobronchial blockers, airway bypass, endobronchial valves, thermal vapor ablation, biological sealants, and airway implants]).
8. Need for mechanical ventilation within 3 months prior to Visit 1.
9. Significant or unstable ischemic heart disease, arrhythmia, cardiomyopathy, heart failure, uncontrolled hypertension as defined by the Investigator, or any other relevant cardiovascular disorder as judged by the Investigator.
10. Narrow angle glaucoma not adequately treated, as deemed by the Investigator. All medications approved for control of intraocular pressures are allowed including topical ophthalmic non-selective beta-blockers (such as betaxolol, carteolol, levobunolol, metipranolol, and timolol), and prostaglandin analogues.
11. Symptomatic prostatic hypertrophy or bladder neck obstruction/urinary retention that, in the opinion of the Investigator, is clinically significant.

Note: Subjects with trans-urethral resection of prostate or full resection of the prostate within 6 months prior to Visit 1 are excluded from the study.

12. Current diagnosis of cancer requiring treatment.

Note: Squamous cell and basal cell carcinomas of the skin are allowed in the study.

Prior/concomitant therapy

13. Unable to withhold short-acting bronchodilators for 6 hours prior to lung function testing at each study visit.

14. Unable to abstain from protocol-defined prohibited medications (see Section 6.5.2) within the time period specified in Table 6 prior to and during Screening and Randomized Treatment periods.
15. Using any herbal products either by inhalation or nebulizer within 2 weeks of Visit 1 and does not agree to stop for the duration of the study.

Prior/concurrent clinical study experience

16. Treatment with investigational study drug (or device) in another clinical study within the last 30 days or 5 half-lives, whichever is longer.
Note: Observational studies (i.e., studies not requiring change to medication or an additional intervention) are allowed.
17. Known hypersensitivity to β_2 -agonists, muscarinic antagonists, or corticosteroids, or any component of the investigational product (IP).

Diagnostic assessments

18. Subjects with calculated creatinine clearance ≤ 30 mL/minute using the Chronic Kidney Disease Epidemiology Collaboration (CKD-EPI) formula.
Note: Subjects with overactive bladder syndrome treated with oral anticholinergics that have been on treatment for at least one month are allowed in the study.
19. Any clinically relevant abnormal findings in physical examination, clinical chemistry, hematology, urinalysis, COVID-19 test, vital signs, or electrocardiogram (ECG), which in the opinion of the Investigator, may put the subject at risk because of his/her participation in the study.
Note: E.g., Clinically relevant abnormal findings in ECGs are defined as QT interval corrected for heart rate (using Fridericia's formula; QTcF) ≥ 500 msec in subjects with QRS < 120 msec and QTcF ≥ 530 msec in subjects with QRS ≥ 120 msec.

Other exclusions

20. Involvement in the planning and/or conduct of the study (applies to both AstraZeneca staff and/or staff at the study site).
21. Judgment by the Investigator that the subject should not participate in the study if the subject is unlikely to comply with study procedures, restrictions and requirements.
22. Previous randomization in the present study except for when the subject had to discontinue study due to study and/or site hold. See section 5.5.2 for details.
23. Women who are pregnant or lactating, planning to become pregnant during the course of the study, or of childbearing potential not using acceptable contraception method.
24. Significant abuse of alcohol or drugs.

5.3 Randomization Criteria

At Visit 3, each subject must meet the following randomization criteria:

1. A pre-dose FEV₁/FVC of <0.70 and FEV₁ of <50% predicted normal value.
2. A pre-dose PIF of <50 L/min using the InCheck Inspiratory Flow Measurement Device set to Turbuhaler S resistance.
3. FEV₁ baseline stability: the -45-minute pre-dose FEV₁ assessments at Visit 3 must be within ±20% or 200 mL of the -45-minute pre-bronchodilator FEV₁ assessments obtained at Visit 2.

5.4 Lifestyle Restrictions

5.4.1 Caffeine and Tobacco

Subjects must not ingest xanthine and/or xanthine analogue (caffeine)-containing foods or beverages or caffeine-containing medications for at least 6 hours prior to the first lung function assessment and for the duration of each in-clinic study visit. Examples of such products include coffee, tea, chocolate, and cola. Decaffeinated beverages are acceptable.

Changes in subject's smoking status (i.e., stopping or re-starting smoking) may have an impact on the efficacy outcome measures. Subjects will be required to refrain from smoking (including medical marijuana and electronic cigarettes) for at least 4 hours prior to the first lung function assessment and until after the last spirometry assessment. Study participants may utilize various nicotine replacement treatments such as chewing gum and patches, as needed, in accordance with recommendations from the Investigator during the entire study visit.

Note: For this study, the use of electronic cigarettes will be treated in the same manner as smoking.

5.4.2 Illicit Drugs or Drugs of Abuse

Illicit drugs or drugs of abuse will not be allowed from Visit 1 to the end of the follow-up telephone call or whenever the subject withdraws from the study. If any illicit drugs or drugs of abuse are used by the subject during the study, the dates of use and the amount will be documented and the subject will be discontinued from randomized study treatment and will be withdrawn from the study at the discretion of the Investigator.

5.5 Screen Failures and Subjects affected by Study or Site Hold

Screen failures are defined as subjects who signed the ICF to participate in the clinical study but are not subsequently randomized to study treatment. A minimal set of screen failure information is required to ensure transparent reporting of screen failure subjects to meet the Consolidated Standards of Reporting Trials (CONSORT) publishing requirements and to respond to queries

from regulatory authorities. Minimal information includes demography, screen failure details, eligibility criteria, and any SAE.

5.5.1 Rescreening Subjects

Subjects may be rescreened as follows:

- Re-screen once if subject(s):
 - Has a moderate or severe exacerbation of COPD and/or COVID-19 or other acute airway infection during screening and prior to randomization and it has been at least 6 weeks following resolution and completion of treatment of these conditions and in the opinion of the PI the subject is able to perform study procedures including spirometry.
- NOTE:** Subjects requiring mechanical ventilation or treatment in the ICU (e.g. for COPD, trauma, infection, recovery from surgery etc.) are not eligible.
- Subjects who did not meet PIF inclusion or randomization criterion with InCheck set for no resistance as per previous CSP version 2.0

5.5.2 Subjects Affected By Study or Site Hold

Subjects that may have been in screening/run-in/randomized and considered either screen failures and/or discontinued when the study or site could be placed on hold on account of COVID-19 pandemic related events for e.g. local health advisory, travel restrictions, etc.; these subjects may be re-invited with a new subject identifier, starting with informed consent process and Visit 1 assessments as appropriate.

For related documentation please refer to Study Procedures Manual instructions.

6. STUDY TREATMENTS

Study treatment is defined as any investigational product(s) (IP) (including marketed product comparator and placebo) or medical device(s) intended to be administered to a study participant according to the study protocol. Study treatment in this study refers to BFF MDI 320/9.6 µg and Symbicort Turbuhaler 320/9 µg (for use during the treatment periods; also referred to as IP) and Berodual and budesonide (for use during run-in and washout periods). All subjects will be provided with Ventolin HFA to use as-needed for relief of COPD symptoms. Instructions for use of Ventolin HFA is provided in [Appendix C](#). Placebo MDIs and DPIs will be provided for training purposes.

InCheck Inspiratory Flow Measurement Devices with disposable mouthpieces for measuring PIF will be provided only at clinic visits (starting from Visit 1) along with all necessary training (see [Appendix J](#)).

6.1 Treatments Administered

6.1.1 Investigational Products

Table 3 Study Treatments

	Treatment*	Treatment*	Run-in/Washout	
Study treatment name:	Budesonide and formoterol fumarate (BFF) MDI 320/9.6 µg	Symbicort Turbuhaler 320/9 µg	Berodual Respimat 20/50 µg ^a	Budesonide MDI 320 µg
Dosage formulation:	160/4.8 µg per actuation	160/4.5 µg per inhalation	20/50 µg per actuation	160 µg per actuation
Route of administration	Oral inhalation via an AeroChamber Plus Flow-Vu spacer device	Oral inhalation	Oral inhalation	Oral inhalation
Dosing instructions:	2 inhalations twice daily	2 inhalations twice daily	1 inhalation 4 times a day	2 inhalations twice daily
Total daily dose	640/19.2 µg	640/18 µg	80/200 µg	640 µg
Packaging and labelling	Study treatment will be provided in MDI. Each MDI will be labelled in accordance with Good Manufacturing Practice (GMP) Annex 13 and per country regulatory requirement.	Study treatment will be provided in DPI. Each DPI will be labelled in accordance with GMP Annex 13 and per country regulatory requirement.	Study treatment will be provided in MDI. Each MDI will be labelled in accordance with GMP Annex 13 and per country regulatory requirement.	Study treatment will be provided in MDI. Each MDI will be labelled in accordance with GMP Annex 13 and per country regulatory requirement.

a. If additional sites are added to the study and Berodual is not available to those sites, Combivent 20/100 µg will be provided.

* Investigational Product

Ventolin HFA will be provided to take 2 inhalations as needed to relieve COPD symptoms throughout the study but should be withheld for 6 hours prior to lung function assessments. Ventolin HFA should not be used with the study provided AeroChamber spacer device.

6.2 Preparation/Handling/Storage/Accountability

All clinical drug supplies should be kept in a locked cabinet or room with limited access. The temperature of the sites' storage area for study treatments must be monitored by site staff for

temperature ranges consistent with those specified for each product as outlined below. Documentation of temperature monitoring should be maintained at the site and available for review.

- MDIs supplies contain contents under pressure. Do not use or store near heat or open flame. Exposure to temperatures above 49°C (120°F) may cause bursting. Never throw clinical drug canisters into a fire or incinerator. Avoid spraying in eyes.
- Symbicort Turbuhaler should be stored below 30°C (86°F). For best results, the inhaler should be at room temperature before use.
- Budesonide MDI and BFF MDI should be stored below 25°C (77°F) in a dry place; excursions permitted up to 30°C (86°F). Do not freeze.
- Berodual should be stored between 15°C (59°F) and 30°C (86°F); Do not freeze.
- Ventolin should be stored between 20°C (68°F) and 25°C (77°F); excursions permitted from 15°C to 30°C (59°F to 86°F).

The Investigator or designee must confirm appropriate temperature conditions have been maintained during transit for all study treatment received and any discrepancies are reported and resolved before use of the study treatment.

Instructions for priming and use of the BFF MDI and budesonide MDI are provided in [Appendix D](#) and [Appendix E](#), respectively. Instructions for the use of Symbicort Turbuhaler is provided in [Appendix F](#). The technique for inhalation from an MDI with a spacer (BFF) is different from the technique used with a DPI (Symbicort). It is important to ensure that subjects apply correct inhalation technique for both types of inhalers in order to participate in the study. Training devices will be available at the study site for instructional purposes, as well as for subjects to practice the correct inhalation technique. **Note: Instruction and practice should occur prior to dispensing study medication and review of subjects' inhalation technique should be done at each visit.** Retraining should occur if required.

All MDIs must be primed before the first use. Priming involves releasing a certain number of sprays (4) into the air before the first use of the inhalers. Shaking and priming the inhaler fills a chamber inside the canister with the correct dose and mix of medication so that the inhaler is ready to use.

Prior to the first use of Symbicort Turbuhaler, the device must be prepared as follows:

- Unscrew the cover and lift it off. You may hear a rattling sound.
- Hold the Turbuhaler upright with the red grip at the bottom.
- Turn the red grip as far as it will go in one direction. Then turn it as far as it will go in the other direction (it does not matter which way you turn first). You should hear a click sound.

- Do this again, turning the red grip on both directions.
- The Turbuhaler is now ready for use.

Specific precautions should be taken to prevent any contamination of collected PK samples by the particles of IP inhalations. All devices must be primed in a separate room (i.e., a different room than will be used to administer IP to subjects) by study personnel before the first use. Administration of IP will take place in a room separate from the room where blood samples are drawn.

The AeroChamber Plus Flow-Vu valve holding chamber (VHC) can be used directly out of the package. Before use, the VHC cap is to be removed and the chamber is to be examined for any obvious defects. Refer to [Appendix F](#) for instructions for use of the AeroChamber Plus Flow-Vu VHC.

Store the VHC at room temperature and keep dry.

Ventolin HFA should not be used with the study provided AeroChamber spacer device.

Only subjects enrolled in the study may receive study treatment and only authorized site staff may supply or administer study treatment. All study treatments must be stored in a secure, environmentally controlled, and monitored (manual or automated) area in accordance with the labelled storage conditions with access limited to the Investigator and authorized site staff.

The Investigator, institution, or the head of the medical institution (where applicable) is responsible for study treatment accountability, reconciliation, and record maintenance (i.e., receipt, reconciliation, and final disposition records).

For each subject, all used study treatment materials will be collected. Used subject supplies will be kept at room temperature in a secure and locked cabinet until returned to Astra Zeneca or designee.

Note: Used study treatment will be stored separately from unused study treatment.

All product complaints (including device malfunctions) must be reported to Astra Zeneca using the Product Complains Form provided in each site's regulatory binder. Astra Zeneca will contact the site to evaluate the nature of the complaint and determine what further action is needed.

6.3 Measures to Minimise Bias: Randomization and Blinding

All subjects will be centrally assigned to randomized study treatment sequence using an interactive web response system (IWRS). Before the study is initiated, the log-in information and directions for the IWRS will be provided to each site.

If a subject withdraws from the study, then his/her subject identifier cannot be reused. Subjects who were discontinued due to COVID-19 and invited back to take part in the study as new subjects will be provided a new subject identifier and randomization code.

Clinical supplies will be packaged to support enrolment of the study. Study personnel will have access to an IWRS to allocate subjects and to assign drug to subjects. Clinical supplies will be packaged according to a component schedule generated by the Sponsor. Each person accessing the IWRS must be assigned an individual unique personal identification number (PIN). They must use only their assigned PIN to access the system and they must not share their assigned PIN with anyone.

This is an open-label study for the personnel at study sites; the specific treatment to be taken by a subject will be assigned using an IWRS. The site will contact the IWRS prior to the start of study treatment administration for each subject. The site will record the treatment assignment on the applicable electronic case report form (eCRF) page, if required. Potential bias will be reduced through central randomization.

Randomization will be stratified by the Visit 3 PIF set to Turbuhaler S resistance (<40 L/min versus \geq 40 L/min).

6.4 Treatment Compliance

Administration of study medication (including rescue Ventolin HFA) should be recorded on the paper diary provided to the subject.

Study treatment compliance will be checked at all visits. Treatment compliance will be verified through the subject reported IP intake from the paper diary. The dose indicator reading will additionally be checked for consistency, to verify that subjects took IP as reported. Dose indicator readings (to the nearest 10) and total inhalations reported in the paper diary will be recorded at the end of each treatment period. Any issues identified will be documented in the appropriate study file and reinstruction will be completed as necessary. Instructions for reading the dose indicator can be found in [Appendix D](#).

6.5 Concomitant Therapy

6.5.1 Allowed Medications

Any current ongoing medications, including over-the-counter medications, herbal supplements, and vaccinations, will be allowed provided they are not explicitly prohibited by the protocol (see [Table 5](#) and [Table 6](#)). All concomitant medications taken during the study will be recorded on the concomitant medications eCRF page with indication, total daily dose, route of administration and dates of drug administration. Any additions, deletions, or changes in the dose of these medications while in the study should be entered in the eCRF. Subjects should also be instructed to contact the Investigator if they develop any illnesses, especially those requiring medicinal interventions.

Subjects who are corticosteroid dependent and maintained on an equivalent of up to 5 mg of prednisone per day or up to 10 mg every other day for at least 3 months prior to Visit 1 are eligible for enrollment.

Ventolin HFA will be provided and is allowed as rescue medication throughout the study; however, no dose shall be taken ≤ 6 hours prior to a clinic visit, including Visit 2. Ventolin HFA should not be used with the study provided AeroChamber spacer device.

Table 4 lists COPD and allergy medications that are allowed as long as the subject has been on a stable dose for at least 30 days prior to Visit 1 and remains on a stable dose throughout the study.

Table 4 Allowed COPD and Allergy Medications

Leukotriene antagonists (e.g., zafirlukast, montelukast, zileuton)
Cromoglycate
Nedocromil
Ketotifen (eyedrops and inhalation solution, where available)
Intranasal corticosteroids, intranasal antihistamines, or combination thereof

Note: Use of cutaneous topical medications, including cutaneous topical corticosteroids, are permitted provided they are not applied to more than 20% of the subject's body surface

6.5.2 Prohibited Medications

6.5.2.1 Prohibited COPD Medications

Specific COPD medications that are prohibited beginning at Visit 1 and their required washout periods prior to Visit 2 are displayed in Table 5.

Table 5 COPD Medications Prohibited Beginning at Visit 1 and Required Washout Period Prior to Visit 2

Medication	Minimum Washout Period Prior to Visit 2
LAMAs	Tiotropium: 14 days Acclidinium: 7 days Glycopyrronium: 7 days Umeclidinium: 7 days
SAMAs	6 hours
LABAs (inhaled)	7 days (14 days for indacaterol and olodaterol)
Fixed-combinations of LABA/LAMA	7 days (14 days for indacaterol/glycopyrronium and olodaterol/tiotropium)
Fixed combinations of LABA/ICS ^a	7 days
Fixed combinations of SABAs and SAMAs ^b	6 hours
SABAs ^c	6 hours
Oral β -agonists	2 days
Theophylline (total daily dose >400 mg/day) ^d	7 days

- With the exception of budesonide MDI (where applicable) provided by the Sponsor at Visit 1 and observe washout of 12 hours prior to study visits
- With the exception of Berodual provided by the Sponsor at Visit 1 (observe washout of 6 hours at Visit 1 and prior to study visits)
- Discontinue and use only Sponsor provided rescue Ventolin HFA throughout the study (observe washout of 6 hours prior to study visit)
- Theophylline (≤ 400 mg/day) is permitted provided the subject has been on a stable dose of therapy for at least 4 weeks prior to Randomization

6.5.2.2 Prohibited Non-COPD and Non-Respiratory Medications and Washout Periods

Subjects requiring medications presented in [Table 6](#) are prohibited from participating in this study. Subjects who recently discontinued use of these medications may be considered for study enrollment provided they have met the minimum cessation period prior to Visit 1. These medications are prohibited through the course of the study. If subjects require any of the prohibited medications listed in [Table 6](#), the Investigator should discuss with the Medical Monitor the suitability of the subject continuing study treatment.

Table 6 Prohibited Non-COPD and Non-Respiratory Medications

Class of Medication^a	Minimum Cessation Period Prior to Visit 1 and Prohibited Throughout the Study
Any drug with potential to significantly prolong the QT interval ^b	14 days or 5 half-lives, whichever is longer
Other investigational drugs	30 days or 5 half-lives, whichever is longer
Non-selective β -blocking agents (except carvedilol)	7 days
Monoamine oxidase inhibitors	14 days
Monoclonal antibodies ^c	30 days or 5 half-lives, whichever is longer
Systemic treatment with potent CYP3A4-inhibitors (e.g., ketoconazole, itraconazole, and ritonavir) and CYP3A4-inducers (e.g., rifampin)	30 days
Systemic anticholinergics ^d	7 days
Chinese complementary and alternative bronchodilatory medicines, i.e., herbal therapies (e.g., <i>Astragalus membranaceus</i> [huáng qí], <i>Panax ginseng</i> [ginseng products], and <i>Cordyceps sinensis</i> , <i>A. membranaceus</i> [ghost moth caterpillar fungus])	10 days

Note: Benzodiazepines and selective serotonin re-uptake inhibitors are not exclusionary.

- Any medications that, in the opinion of the Investigator, would impact the safety of the study or the outcome of the study is prohibited.
- Subjects who are on medications that have the potential to prolong the QTc interval may be enrolled provided the dose has remained stable for at least 3 months prior to Visit 1, the subject meets all of the ECG inclusion criteria and none of the ECG exclusion criteria, and if, in the opinion of the Investigator, there are no safety concerns for the subject to participate in the study. Initiation of medications with the potential to significantly prolong the QT interval is prohibited throughout the Screening and Randomized Treatment Periods.
- Investigators should contact the Medical Monitor to determine the appropriateness and safety of continuing study drug on a case by case basis (e.g., XOLAIR[®] [omalizumab] will not be allowed, whereas a monoclonal antibody for another indication, such as osteoporosis, may be allowed after consultation with the Medical Monitor).
- If systemic anticholinergics are used for the treatment of overactive bladder and the treatment has been constant for at least 1 month, they are allowed.

6.5.3 Other Concomitant Treatment

Medication other than that described above, which is considered necessary for the subject's safety and wellbeing, may be given at the discretion of the Investigator and recorded in the appropriate sections of the eCRF.

6.6 Dose modification

Not applicable for this study.

6.7 Treatment After the End of the Study

At the end of the Randomized Treatment Period, the Investigator should prescribe alternative COPD therapy for the subject. There will be no provisions to supply BFF MDI or Symbicort Turbuhaler after the end of the treatment period.

7. DISCONTINUATION OF TREATMENT AND SUBJECT WITHDRAWAL

7.1 Discontinuation of Study Treatment

Subjects may be discontinued from IP in the following situations:

- Subject decision. The subject is at any time free to discontinue treatment, without prejudice to further treatment
- Adverse event (e.g. paradoxical bronchospasm, severe allergic reaction)
- Severe non-compliance with the Clinical Study Protocol
- Development of exclusion criteria or other safety reasons as judged by the Investigator during the treatment period e.g COVID-19 pandemic related discontinuation (see details in section [4.1.1.1](#))

See the SoA ([Table 1](#)) for data to be collected at the time of treatment discontinuation and follow-up and for any further evaluations that need to be completed.

7.1.1 Procedures for Discontinuation of Study Treatment

The Investigator should instruct the subject to contact the site before or at the time if study treatment is stopped. A subject that decides to discontinue study treatment will always be asked about the reason(s) and the presence of any AEs. The date of last intake of study treatment should be documented in the eCRF. All study treatment should be returned by the subject at their next on-site study visit or unscheduled visit. Subjects permanently discontinuing study treatment should be given locally available standard of care therapy, at the discretion of the Investigator.

7.2 Lost to Follow-Up

A subject will be considered potentially lost to follow-up if he or she fails to return for scheduled visits and is unable to be contacted by the study site.

The following actions must be taken if a subject fails to return to the clinic for a required study visit:

- The site must attempt to contact the subject and reschedule the missed visit as soon as possible and counsel the subject on the importance of maintaining the assigned visit schedule.
- Before a subject is deemed lost to follow up, the Investigator or designee must make every effort to regain contact with the subject by repeat telephone calls. These contact attempts should be documented in the subject's medical record.
- Should the subject be unreachable at the end of the study, the subject should be considered to be lost to follow-up.

7.3 Withdrawal From the Study

A subject may withdraw from the study (e.g., withdraw consent), at any time (IP and assessments) at his/her own request, without prejudice to further treatment.

If the subject withdraws consent for disclosure of future information, the Sponsor may retain and continue to use any data collected before such a withdrawal of consent.

If a subject withdraws from the study, he/she may request destruction of any samples taken, and the Investigator must document this in the site study records.

A subject who withdraws consent will always be asked about the reason(s) and the presence of any AEs. The Investigator will follow up subjects as medically indicated.

See SoA (Table 1), for data to be collected at the time of study discontinuation and follow-up and for any further evaluations that need to be completed. All study treatment should be returned by the subject.

7.4 Study and Site Closure

The sponsor designee reserves the right to close the study site or terminate or place the study on hold at any time for any reason at the sole discretion of the sponsor. The study may be stopped if, in the judgment of AstraZeneca, trial subjects are placed at undue risk because of clinically significant findings that:

- meet individual stopping criteria or are otherwise considered significant
- are assessed as causally related to study drug,
- are not considered to be consistent with continuation of the study

Regardless of the reason for termination, all data available for the subject at the time of discontinuation of follow-up must be recorded in the CRF. All reasons for discontinuation of treatment must be documented.

In terminating the study, the Sponsor will ensure that adequate consideration is given to the protection of the subjects' interests

Study sites will be closed upon study completion. A study site is considered closed when all required documents and study supplies have been collected and a study-site closure visit has been performed.

The investigator may initiate study-site closure at any time, provided there is reasonable cause and sufficient notice is given in advance of the intended termination.

Reasons for the early closure of a study site by the sponsor or investigator may include but are not limited to:

- Failure of the investigator to comply with the protocol, the requirements of the IRB/IEC or local health authorities, the sponsor's procedures, or GCP guidelines
- Inadequate recruitment of participants by the investigator
- Discontinuation of further study intervention development

8. STUDY ASSESSMENTS AND PROCEDURES

Study procedures and their timing are summarised in the SoA ([Table 1](#)).

The Investigator will ensure that data are recorded on the eCRF.

The Investigator ensures the accuracy, completeness, legibility and timeliness of the data recorded and of the provision of answers to data queries according to the Clinical Study Agreement. The Investigator will sign the completed eCRFs. A copy of the completed eCRFs will be archived at the study site.

Immediate safety concerns should be discussed with the Sponsor immediately upon occurrence or awareness to determine if the subject should continue or discontinue study treatment.

Adherence to the study design requirements, including those specified in the SoA, is essential and required for study conduct.

All screening evaluations must be completed and reviewed to confirm that potential subjects meet all eligibility criteria. The Investigator will maintain a screening log to record details of all subjects screened and to confirm eligibility or record reasons for screening failure, as applicable.

8.1 Efficacy Assessments

8.1.1 Pulmonary Function Tests

All pulmonary function tests (PFTs) including FEV₁ and FEV₁/FVC as defined in ATS/ERS guidelines will be performed in accordance with ATS criteria ([Appendix H, Miller, 2005](#)) and will be assessed using a spirometer that meets or exceeds minimum performance recommendations of the ATS ([Appendix I](#)). Pulmonary function tests will be limited to 3 attempts. Every effort should be made to get 3 reproducible and acceptable maneuvers; however, if this is not possible, the best of the 3 attempts will be recorded.

To standardize spirometry, all sites will be provided with identical spirometry systems (eResearch Technology [ERT], Philadelphia, PA, US) with customized, study-specific software. All study staff responsible for performing PFTs will receive standardized training. As much as possible, spirometry assessments should be administered by the same person across the study population.

The volume accuracy of the spirometer is to be checked daily using a 3 L syringe across 3 flow ranges (i.e., low, medium, and high flows), with temperature and barometric pressure correction. The calibration syringe must meet ATS specifications and must not be used beyond the expiry date. Required accuracy is $\pm 3\%$ (i.e., 3.09 L to 2.91 L; ATS/ERS). The results will be printed and maintained in a calibration log, which will be monitored for compliance during the monitoring visits.

As spirometry results are primary and secondary efficacy endpoints for this study, it is important for the medication withholding conventions and timing of spirometry to be consistently managed throughout the study.

Spirometry collection is briefly outlined below. For exact spirometry collection and specifications, please refer to the SoA ([Table 1](#)).

At Visit 2, spirometry assessments will be obtained approximately 45 minutes pre-bronchodilator and 30 to 60 minutes post-bronchodilator. Reversibility will be calculated to characterize the subject population. Reversibility is defined as $\geq 12\%$ and ≥ 200 mL improvement in baseline FEV₁ following administration of 4 puffs of Ventolin HFA. The procedure is as follows:

- Perform pre-bronchodilator PFT approximately 45 minutes prior to administration of Ventolin HFA
- Administer 4 puffs of Ventolin HFA
- Perform post-bronchodilator PFT within 30 to 60 minutes after administration of Ventolin HFA

At Visits 3 and 5 (Day 1 of each Treatment Period), spirometry will be obtained approximately 45 minutes pre-dose and 2 hours post-dose. At Visits 4 and 6 (Day 8 of each Treatment Period) spirometry will be obtained approximately 45 minutes pre-dose and 30 minutes and 1, 2, and 4

hours post-dose. If spirometry and PK assessments are to be performed at the same timepoint, PK samples should be drawn first followed by spirometry measurements. Spirometry will be collected at the Early Discontinuation/Withdrawal Visit only if the subject is still taking IP (last dose of IP on day before or day of visit).

FEV₁ baseline stability criteria at Visit 3 (as defined in section 5.3) must be met in order for subjects to be randomized to treatment.

8.1.2 Peak Inspiratory Flow

Training for the use of the InCheck Inspiratory Flow Measurement Device will be provided to the subject at Visit 2. For instructions on the InCheck Inspiratory Flow Measurement Device see [Appendix J](#).

Peak inspiratory flow collection is briefly outlined below. For exact PIF collection and specifications, please refer to the SoA ([Table 1](#)).

At Visits 2, 3, 4, 5, and 6 (Screening and Days 1, 8, 22, and 29), PIF will be measured with the InCheck Inspiratory Flow Measurement Device set to no resistance and then repeated with the resistance equal to Turbuhaler S and then equal to ELLIPTA. For each resistance level, triplicate measurements of pre-dose PIF assessment will be conducted and all 3 measurements will be captured in the eCRF. The average of the 3 measurements with the device set to Turbuhaler S resistance will be used to determine eligibility at Visit 2 and Visit 3.

8.1.3 Inspiratory Capacity

On Day 1 of each Treatment Period (Visits 3 and 5), IC assessments will be conducted approximately 45 minutes pre-dose and prior to any other spirometry assessments and 2 hours post-dose. On Day 8 of each Treatment Period (Visits 4 and 6), IC assessments will be conducted 2 hours post-dose.

All subjects will be instructed on the performance of the IC maneuver. Subjects must be tested in the seated position wearing a nose clip with no air leaks between the mouth and the mouthpiece. Subjects should be relaxed with shoulders down and asked to breathe regularly for several breaths until the end-expiratory lung volume is stable (this usually requires at least 5 tidal maneuvers). The subject is then urged to take a deep breath to total lung capacity with no hesitation.

Inspiratory capacity tests will be limited to 3 attempts. Every effort should be made to get 3 acceptable trials; however, if this is not possible, the best (highest value) of the 3 attempts will be recorded.

8.1.4 Chronic Obstructive Pulmonary Disease Assessment Test (CAT)

The CAT is an 8-item Patient Reported Outcomes developed to measure the overall impact of COPD on health status [[Jones, 2009](#), [Appendix K](#)]. The instrument uses semantic differential

six-point response scales which are defined by contrasting adjectives to capture the impact of COPD. Content includes items related to cough, phlegm, chest tightness, breathlessness going up hills/stairs, activity limitation at home, confidence leaving home, sleep and energy. A CAT total score is the sum of item responses. Scores range from 0-40 with higher scores indicative of greater COPD impact on health status.

Subjects will complete the CAT at Visit 2 for screening purposes only.

8.2 Safety Assessments

Planned time points for all safety assessments are provided in the SoA (Table 1).

8.2.1 Clinical Laboratory Assessments

Clinical safety laboratory tests will be analyzed by a local laboratory according to standardized, validated assays for screening purposes only. See Table 7 for the list of clinical safety laboratory tests to be performed at Screening (Visit 1).

The Investigator should make an assessment of the available results with regard to clinically relevant abnormalities. The laboratory results should be signed and dated and retained at the center as source data for laboratory variables.

Table 7 Laboratory Safety Variables

Hematology (whole blood)	Clinical Chemistry (serum or plasma)
Hemoglobin	Creatinine
White blood cell count with differential	Potassium
Eosinophil count	Sodium
	Liver Enzyme/Other Liver Function Tests
	Alanine aminotransferase (ALT)
	Aspartate aminotransferase (AST)

8.2.2 Physical Examinations and Other Screening Assessments

Medical history including smoking status will be collected at Visit 1. The number of COPD exacerbations requiring oral corticosteroids and/or antibiotics, or hospitalization within 12 months of Visit 1 will be collected.

A complete physical examination will be performed at Visit 1 and include assessment of the following: general appearance, respiratory, cardiovascular, and abdomen. Weight assessed in ordinary indoor clothing with shoes removed and height will be recorded at Visit 1.

Vital signs (blood pressure and pulse) and ECGs will be performed for screening purposes only.

8.3 Collection of Adverse Events

The Principal Investigator is responsible for ensuring that all staff involved in the study are familiar with the content of this section.

The definitions of an AE or SAE can be found in [Appendix L](#).

AE will be reported by the subject (or, when appropriate, by a caregiver, surrogate, or the subject's legally authorized representative).

The Investigator and any designees are responsible for detecting, documenting, and recording events that meet the definition of an AE or SAE. For information on how to follow-up AEs see Section [8.3.3](#).

8.3.1 Method of Detecting AEs and SAEs

Care will be taken not to introduce bias when detecting AEs and/or SAEs. Open-ended and non-leading verbal questioning of the subject is the preferred method to inquire about AE occurrences.

8.3.2 Time Period and Frequency for Collecting AE and SAE Information

Non-serious adverse events will be collected from Randomization throughout the Treatment Period and including the washout and follow-up periods.

Serious adverse events will be recorded from the time of signing of informed consent form.

All SAEs will be recorded and reported to the Sponsor or designee within 24 hours, as indicated in [Appendix L](#). The Investigator will submit any updated SAE data to the Sponsor within 24 hours of it being available.

Investigators are not obligated to actively seek AE or SAE in former study subjects; however, if the Investigator learns of any SAE, including a death, at any time after a subject's last visit and he/she considers the event to be reasonably related to the study treatment or study participation, the Investigator may notify the Sponsor.

The method of recording, evaluating, and assessing causality of AE and SAE and the procedures for completing and transmitting SAE reports are provided in [Appendix L](#).

8.3.3 Follow-Up of AEs and SAEs

After the initial AE/SAE report, the Investigator is required to proactively follow each subject at subsequent visits/contacts. All SAEs and non-serious AEs will be followed until resolution, stabilization, the event is otherwise explained, or the subject is lost to follow-up

Any AEs that are unresolved at the subject's last AE assessment in the study are followed up by the Investigator for as long as medically indicated, but without further recording in the eCRF. AstraZeneca retains the right to request additional information for any subject with ongoing AE(s)/SAE(s) at the end of the study, if judged necessary.

8.3.4 Adverse Event Data Collection

The following variables will be collected for each AE;

- AE (verbatim)
- The date when the AE started and stopped
- Maximum intensity
- Whether the AE is serious or not
- Investigator causality rating against the IP(s) (yes or no)
- Action taken with regard to IP(s)
- AE caused subject's withdrawal from study (yes or no)
- Outcome

In addition, the following variables will be collected for SAEs:

- Date AE met criteria for SAE
- Date Investigator became aware of SAE
- AE is serious due to
- Date of hospitalization
- Date of discharge
- Probable cause of death
- Date of death
- Autopsy performed
- Causality assessment in relation to study procedure(s)
- Causality assessment to other medication

8.3.5 Causality Collection

The Investigator will assess causal relationship between IP and each AE, and answer 'yes' or 'no' to the question 'Do you consider that there is a reasonable possibility that the event may have been caused by the IP?'

For SAEs, causal relationship will also be assessed for other medication and study procedures. Note that for SAEs that could be associated with any study procedure the causal relationship is implied as ‘yes’.

A guide to the interpretation of the causality question is found in [Appendix L](#).

8.3.6 Adverse Events Based on Signs and Symptoms

All AEs spontaneously reported by the subject or reported in response to the open question from the study site staff: ‘Have you/the child had any health problems since the previous visit/you were last asked?’ or revealed by observation will be collected and recorded in the eCRF. When collecting AEs, the recording of diagnoses is preferred (when possible) to recording a list of signs and symptoms; however, if a diagnosis is known and there are other signs or symptoms that are not generally part of the diagnosis, the diagnosis and each sign or symptom will be recorded separately.

8.4 Safety Reporting and Medical Management

8.4.1 Reporting of Serious Adverse Events

All SAEs have to be reported, whether or not considered causally related to the IP, or to the study procedure(s). All SAEs will be recorded in the eCRF.

If any SAE occurs in the course of the study, then Investigator or other site personnel inform the appropriate AstraZeneca representatives within one day i.e., immediately but **no later than 24 hours** of when he or she becomes aware of it.

The designated AstraZeneca representative works with the Investigator to ensure that all the necessary information is provided to the AstraZeneca Patient Safety data entry site **within 1 calendar day** of initial receipt for fatal and life-threatening events **and within 5 calendar days** of initial receipt for all other SAEs.

For fatal or life-threatening AEs where important or relevant information is missing, active follow-up is undertaken immediately. Investigators or other site personnel inform AstraZeneca representatives of any follow-up information on a previously reported SAE within one calendar day i.e., immediately but **no later than 24 hours** of when he or she becomes aware of it.

For further guidance on the definition of a SAE, see [Appendix L 2](#).

AstraZeneca will provide Regulatory Authorities, Ethics Committees, and Principal Investigators with safety updates/reports according to local requirements.

8.4.2 Pregnancy

All pregnancies and outcomes of pregnancy should be reported to AstraZeneca from Visit 1 until study completion.

If a pregnancy is reported, the Investigator should inform the Sponsor within 24 hours of learning of the pregnancy.

Abnormal pregnancy outcomes (e.g., spontaneous abortion, fetal death, stillbirth, congenital anomalies, ectopic pregnancy) are considered SAEs.

8.4.2.1 Maternal Exposure

If a subject becomes pregnant during the course of the study, IP should be discontinued immediately.

Pregnancy itself is not regarded as an AE unless there is a suspicion that the IP under study may have interfered with the effectiveness of a contraceptive medication. Congenital abnormalities/birth defects and spontaneous miscarriages should be reported and handled as SAEs. Elective abortions without complications should not be handled as AEs. The outcome of all pregnancies (spontaneous miscarriage, elective termination, ectopic pregnancy, normal birth or congenital abnormality) should be followed up and documented even if the subject was discontinued from the study.

If any pregnancy occurs in the course of the study, then the Investigator or other site personnel informs the appropriate AstraZeneca representatives within 1 day i.e., immediately but **no later than 24 hours** of when he or she becomes aware of it.

The designated AstraZeneca representative works with the Investigator to ensure that all relevant information is provided to the AstraZeneca Patient Safety data entry site within 1 or 5 calendar days for SAEs (see Section 8.4.1) and within 30 days for all other pregnancies.

The same timelines apply when outcome information is available.

8.4.3 Overdose

For this study, any dose of BFF MDI greater than 320/9.6 µg twice daily will be considered an overdose.

The Sponsor does not recommend specific treatment for an overdose.

- An overdose with associated AEs is recorded as the AE diagnosis/symptoms on the relevant AE modules in the eCRF and on the Overdose eCRF module.
- An overdose without associated symptoms is only reported on the Overdose eCRF module

If an overdose on an AstraZeneca study drug occurs in the course of the study, then the Investigator or other site personnel inform appropriate AstraZeneca representatives immediately, or **no later than 24 hours** of when he or she becomes aware of it.

The designated AstraZeneca representative works with the Investigator to ensure that all relevant information is provided to the AstraZeneca Patient Safety data entry site.

For overdoses associated with a SAE, the standard reporting timelines apply, see Section 8.4.1. For other overdoses, reporting must occur within 30 days.

8.4.4 Medication Error

If a medication error occurs in the course of the study, the Investigator or other site personnel informs the appropriate AstraZeneca representative within 1 day i.e., immediately, but no later than 24 hours of when he/she becomes aware of it.

The designated AstraZeneca representative works with the Investigator to ensure that all relevant information is completed within 1 (Initial Fatal/Life-Threatening or follow-up Fatal/Life-Threatening) or 5 (other serious initial and follow-up) calendar days if there is an SAE associated with the medication error (see Section 8.4.1) and within 30 days for all other medication errors.

The definition of Medication Error can be found in Appendix L 8.

8.5 Pharmacokinetics

Pharmacokinetic assessments will be obtained at Visits 4 and 6 (after the morning dose on Day 8 of each treatment period). Sample collections will be scheduled for the nominal timepoint and actual collection times will be recorded in the source documents.

8.5.1 Procedure for Blood Sample Collection and Schedule

Pre-dose Administration Sample Collection – Visits 4 and 6: Approximately 10 mL of whole blood will be collected within 30 minutes before administration of study drug.

Post-dose Administration Sample Collection – Visits 4 and 6: Approximately 10 mL of whole blood will be collected at 2, 5, 20, 30, and 40 minutes and 1, 2, 3, and 4 hours post-dose.

If spirometry and PK assessments are to be performed at the same timepoint, PK samples should be drawn first followed by spirometry measurements.

Collection and storage of PK samples will be detailed in the laboratory manual.

8.5.2 Determination of Drug Concentration

Samples for determination of budesonide and formoterol concentration in plasma will be analyzed by Covance on behalf of AstraZeneca using an appropriate bioanalytical method. Full details of the analytical method used will be described in a separate bioanalytical report.

8.5.3 Storage and Destruction of PK Samples

Pharmacokinetic samples will be disposed of after the Bioanalytical Report finalization or 6 months after issuance of the draft Bioanalytical Report (whichever is earlier), unless requested for future analyses.

Pharmacokinetic samples may be disposed of or destroyed and anonymized by pooling. Additional analyses may be conducted on the anonymized, pooled PK samples to further evaluate and validate the analytical method. Any results from such analyses may be reported separately from the clinical study report.

Incurred sample reproducibility analysis, if any, will be performed alongside the bioanalysis of the test samples. The results from the evaluation will not be reported in the clinical study report but separately in a bioanalytical report.

8.6 Pharmacodynamics

Pharmacodynamic parameters are not evaluated in this study.

8.7 Genetics

8.8 Biomarkers

Biomarkers are not evaluated in this study.

8.9 Medical Resource Utilization and Health Economics

Medical resource utilization and health economics data is not evaluated in this study.

9. STATISTICAL CONSIDERATIONS

9.1 Statistical Hypotheses

The purpose of this pilot study is to obtain reasonable estimates of treatment effects related to device, as well as variability, for the primary and secondary endpoints. These will be used to further inform on the design and sample size needed for future studies. Therefore, the focus will be on estimation of individual treatment effects and estimated differences between the treatments. Therefore, there will be no formal hypothesis testing for this pilot study, and exploratory hypotheses only will be evaluated.

9.2 Sample Size Determination

A total of approximately 30 subjects, 15 per sequence, (with at least 26 subjects completing the study) are planned to be randomized in this study. The sample size has been selected based on practical considerations to obtain reasonable estimates for the primary and secondary objectives of this study, which will be used to further inform on the design and sample size needed for future studies.

9.3 Populations for Analyses

For purposes of analyses, the following populations are defined:

Population	Description
Enrolled	All subjects who sign the ICF.
Intent-to-Treat (ITT) Population	<p>All subjects who are randomized to treatment and receive at least one dose of study treatment. Subjects will be analyzed according to the treatment they were assigned to as randomized, regardless of the treatment actually received.</p> <p>Subjects affected by the study being put on hold for the COVID-19 pandemic will be handled as follows:</p> <ul style="list-style-type: none"> • Subjects who were discontinued due to the study being put on hold and who restarted the study will only be included in the ITT analysis set for the instance of enrolment after they restarted. • Discontinued subjects who do not restart will be included in the ITT analysis set. <p>This ensures that all randomized subjects are included in the ITT set once and once only.</p>
Modified ITT (mITT) Population	<p>All subjects in the ITT Population with post-baseline spirometry data from both treatment periods at Visits 4 and 6. Data judged to be impacted by major protocol violations will be excluded. Subjects will be analyzed according to the treatment they were assigned to as randomized.</p> <p>Subjects affected by the study being put on hold for the COVID-19 pandemic will be handled as follows:</p> <ul style="list-style-type: none"> • Subjects who were discontinued due to the study being put on hold and who restarted the study will only be included in the mITT analysis set for the instance of enrolment after they restarted, if they have post-baseline spirometry data for both treatment periods after restart and meet the definition described above. • Discontinued subjects who do not restart will not be included in the mITT analysis set as they will not have post-baseline spirometry data from both treatment periods. <p>This ensures that all randomized subjects are included in the mITT set at most once, if they meet the relevant definition.</p>

<p>Safety Population</p>	<p>All subjects who are randomized to treatment and receive at least one dose of the study treatment. Subjects will be analyzed according to the treatment actually received.</p> <p>Subjects affected by the study being put on hold for the COVID-19 pandemic will be handled as follows:</p> <ul style="list-style-type: none"> • Subjects who were discontinued due to the study being put on hold and who restarted the study will only be included in the Safety analysis set for the instance of enrolment after they restarted. • Discontinued subjects who do not restart will be included in the Safety analysis set. <p>This ensures that all randomized subjects are included in the Safety set once and once only.</p>
<p>PK Population</p>	<p>All subjects in the mITT population with C_{max} defined in both treatment periods. Subjects will be analyzed according to the treatment actually received.</p>

Important protocol deviations and those which lead to exclusion from the mITT population will be described in the statistical analysis plan and confirmed prior to unblinding of the study.

Demographics and other baseline characteristics will be summarized using the ITT and mITT Populations. The mITT Population will be used to summarize the primary and secondary efficacy variables. The ITT Population will be used for sensitivity analyses for the primary endpoint. The Safety Population will be used to summarize safety data. Pharmacokinetic Population will be used to summarize the PK analyses.

As there will be some subjects who were discontinued due to COVID-19, who will be invited back to the study after study restart, there will be data on these subjects from two instances: before and after the study being put on hold. Data on these subjects from both instances will be presented in listings. Only subjects having complete data from both treatment periods, entirely before or entirely after study restart will be included in the mITT Population and used in primary efficacy analyses. If any of these subjects discontinue after restart, they will still be included in the ITT and Safety Population.

Subjects who were randomized and discontinued due to the study being put on hold, but who choose not to come back after study restart will have their data included in the ITT and Safety Population only.

9.4 Statistical Analyses

Analyses will be performed by AstraZeneca or its representatives. A comprehensive statistical analysis plan will be developed and finalized before database lock and will describe the subject

populations to be included in the analyses, and procedures for accounting for missing, unused, and spurious data. This section is a summary of the planned statistical analyses of the primary and secondary endpoints. Any deviations from this plan will be reported in the clinical study report.

9.4.1 Baseline for Analyses

For all endpoints, baseline is defined as the mean of the pre-dose value from the start of each period at Visits 3 and 5. This will be used for statistical analyses unless otherwise specified.

9.4.2 Visit Windows

No study time windows will be derived by visit and data will be presented according to the scheduled study day. For spirometry endpoints by timepoint pre- and post-dosing, the assessments will be allocated to derived nominal collection time windows of minutes from IP dosing. These will be specified in the Statistical Analysis Plan. Actual time will be used for the AUC calculations.

9.4.3 Efficacy Analyses

All primary and secondary efficacy analyses will be conducted using the mITT Population. In addition, a sensitivity analysis will be conducted for the primary endpoint using the ITT population. Subjects will be analyzed according to the treatment randomized.

9.4.3.1 Primary Efficacy Analysis

Peak change from baseline in FEV₁ within 4 hours post-dose following 1 week of treatment

Peak change from baseline in FEV₁ within 4 hours post-dose is defined as the maximum of the FEV₁ assessments within 4 hours post-dosing at each visit minus baseline, provided that there are at least 2 non-missing values during the first 4 hours post-dose.

The peak change from baseline in FEV₁ will be analyzed in the mITT population using an analysis of covariance (ANCOVA) model with baseline FEV₁, PIF at screening and reversibility to Ventolin HFA as continuous covariates and treatment, and period as categorical covariates. The model will include subject as a random effect to model correlation within subject across the study. The model will not include treatment sequence unless that term is determined to be important ($p < 0.10$). 95% confidence intervals (CIs) will be produced. P-values will be produced to aid interpretation although these will not be inferential.

9.4.3.2 Analysis of Secondary Efficacy Variables

FEV₁ AUC_{0-4 h} following 1 week of treatment

FEV₁ AUC_{0-4 h} will be calculated using the trapezoidal rule and will be normalized by dividing by the time in hours from dosing to the last measurement included (typically 4 hours). Only one non-missing post-dose value is required for the calculation of AUC. It will be analyzed in a similar fashion to the primary efficacy analysis.

Change from baseline in pre-dose FEV₁ following 1 week of treatment

Change from baseline in pre-dose FEV₁ following 1 week of treatment is defined as the 45-minute pre-dose value following 1 week of treatment minus baseline. In subjects missing either of these pre-dose assessments, the value will be calculated from the single measurement. It will be analyzed in a similar fashion to the primary efficacy analysis.

Change from baseline in 2-hour post-dose IC following 1 week of treatment

Change from baseline in 2-hour post-dose IC following 1 week of treatment will be defined as the 2-hour post-dose assessment of IC following 1 week of treatment minus baseline IC and analyzed in a similar fashion to the primary efficacy analysis.

Change from baseline in pre-dose PIF following 1 week of treatment

Change from baseline in pre-dose PIF following 1 week of treatment will be defined as the pre-dose PIF following 1 week of treatment minus baseline PIF and analyzed in a similar fashion to the primary efficacy analysis.

At each visit, PIF will be measured with the InCheck Inspiratory Flow Measurement Device set to no resistance and then repeated with the resistance equal to Turbuhaler S and then equal to ELLIPTA. Change from baseline in pre-dose PIF with different resistances will be analyzed separately in a similar fashion.

Change from baseline in 2-hour post-dose FEV₁ following the 1st dose of treatment

Change from baseline in 2-hour post-dose FEV₁ following the 1st dose of treatment will be defined as the 2-hour post-dose assessment of FEV₁ following the 1st dose of treatment (Visit 3 or 5) minus baseline FEV₁ and analyzed in a similar fashion to the primary efficacy analysis.

Change from baseline in 2-hour post-dose IC following the 1st dose of treatment

Change from baseline in 2-hour post-dose IC following the 1st dose of treatment will be defined as the 2-hour post-dose assessment of IC following the 1st dose of treatment (Visit 3 or 5) minus baseline IC and analyzed in a similar fashion to the primary efficacy analysis.

Supportive analyses

A sensitivity analysis will be conducted for the primary endpoint in the ITT population using a similar ANCOVA model. Sensitivity analyses will be considered in the ITT population for the secondary endpoints should the mITT and ITT populations differ substantially.

Subgroup analyses based upon PIF at screening will also be performed for primary and secondary endpoints. The relationship of treatment effects to PIF will be investigated graphically.

An additional sensitivity analysis to assess the impact of COVID-19 related study restart will be carried out and details will be outlined in the SAP.

9.4.3.3 Estimand

The estimand of interest is the per protocol estimand. This is the effect of the randomized treatment in all subjects who are compliant with the protocol (no major protocol violations), including the use of randomized medication. This will enable estimation of the effects that could be attributed purely to device, rather than to adherence or other factors.

Analyses for the per protocol estimand will be conducted using the mITT Population where only data from subjects completing both treatment periods, without major protocol violations, will be utilized.

9.4.1 Safety Analyses

All safety summaries will be performed on the Safety Population. Subjects will be analyzed according to the actual treatment received.

Adverse events in each Treatment Period will be summarized by the number of subjects experiencing an event. They will be tabulated at the level of the Medical Dictionary for Regulatory Activities (MedDRA) preferred term and the MedDRA system organ class. The version of MedDRA current at the time of database lock will be used for the final analysis of data. Tabulations will be broken down by intensity, seriousness, AEs leading to discontinuation of study drug, and by relationship to study drug. No hypothesis tests will be performed. Tables will show the overall incidence of AEs, and the incidence for each treatment.

9.4.2 Pharmacokinetic Analyses

Pharmacokinetic and statistical analysis will be performed using the PK population. The estimation of PK parameters will be performed using non-compartmental methods.

Pharmacokinetic parameters calculated using pre-defined post-dose serial blood draws over 4 hours on after the last dose (in the morning on Day 8) of each Treatment Period will include the following:

- C_{\max}
- AUC_{0-4}
- t_{\max}
- C_{trough}

Other PK parameters may be calculated, as appropriate.

Descriptive statistics for plasma concentrations of budesonide and formoterol by treatment and nominal time point will be summarized on the raw and log-normal scales using the PK

Population. Individual plasma concentration at each nominal and actual time point for each treatment will be listed by subject using the Safety Population.

All budesonide and formoterol PK parameters will be listed and summarized by treatment using appropriate descriptive statistics.

The log transformed C_{max} will be analyzed for PK Population using an ANCOVA model with treatment, period as categorical covariates. The model will include subject as a random effect to model correlation within subject across the study. The model will not include treatment sequence unless that term is determined to be important ($p < 0.10$). Ratios and 90% CIs for C_{max} will be produced by back transformation. AUC_{0-4} will be analyzed similarly.

9.4.3 Methods for Multiplicity Control

As this is a pilot study, without formal hypothesis testing, no correction for multiplicity will be applied.

9.5 Interim analyses

Not applicable

10. REFERENCES

Altman P, Wehbe L, Juergen D, et al. Comparison of peak inspiratory flow rate via the Breezhaler[®], Ellipta[®] and HandiHaler[®] dry powder inhalers in patients with moderate to very severe COPD: a randomized crossover trial. *BMC Pulmonary Medicine* 2018;18:100-107.

Celli B, MaNee W, Agusti A, et al. Standards for the diagnosis and treatment of subjects with COPD: as summary of the ATS/ERS position paper. *Eur Respir J* 2004;23:932-946.

Ferguson GT, Papi A, Anzueto A, et al. Budesonide/formoterol MDI with co-suspension delivery technology in COPD: the TELOS study. *Eur Respir J* 2018;52:1801334.

Global Strategy for the Diagnosis, Management, and Prevention of COPD. Global Initiative for Chronic Obstructive Lung Disease (GOLD) 2018. Available online at: <http://www.goldcopd.org>.

Jones PW, Harding G, Berry P, et al. Development and first validation of the COPD Assessment Test. *Eur Respir J* 2009;34:648-654.

Loh CH, Peters SP, Lovings TM, Ohar JA. Suboptimal Inspiratory Flow Rates Are Associated with Chronic Obstructive Pulmonary Disease and All-Cause Readmission. *AnnalsATS* 2017;14(8):1305-1311.

Mahler DA. Peak Inspiratory Flow Rate as a Criterion for Dry Powder Inhaler Use in Chronic Obstructive Pulmonary disease. *Ann Am Thorac Soc* 2017;14(7):1103-1107.

Miller MR, Hankinson J, Brusasco V, et al. Standardisation of spirometry. *Eur Respir J* 2005;26(2):319-338.

Sharma G, Mahler DA, Mayorga VM, et al. Prevalence of Low Peak Inspiratory Flow Rate at Discharge in Patients Hospitalized for COPD Exacerbation. *JCOPD* 2017;4(3):217-224.

11. SUPPORTING DOCUMENTATION AND OPERATIONAL CONSIDERATIONS

Appendix A Instructions for Use of Berodual Respimat

Introduction Berodual Respimat (ipratropium bromide and fenoterol hydrobromide). Read these Instructions for Use before you start using Berodual Respimat



- If Berodual Respimat has not been used for more than 7 days release one puff towards the ground.
- If Berodual Respimat has not been used for more than 21 days repeat steps 4 to 6 under 'Prepare for first use' until a cloud is visible. Then repeat steps 4 to 6 three more times.
- Do not touch the piercing element inside the clear base.

How to care for your Berodual Respimat

Clean the mouthpiece including the metal part inside the mouthpiece with a damp cloth or tissue only, at least once a week.

Any minor discoloration in the mouthpiece does not affect your Berodual Respimat inhaler performance.

If necessary, wipe the outside of your Berodual Respimat inhaler with a damp cloth.

When to get a new Berodual Respimat







- Your Berodual Respimat inhaler contains 120 puffs (120 doses) if used as indicated.
- The dose indicator shows approximately how much medication is left.
- When the dose indicator enters the red area of the scale you need to get a new prescription; there is approximately medication for 7 days left (28 puffs).
- Once the dose indicator reaches the end of the red scale, your BERODUAL RESPIMAT locks automatically – no more doses can be released. At this point, the clear base cannot be turned any further.
- Berodual Respimat should be discarded three months after you have prepared it for first use, even if it has not been fully used or used at all.

Prepare for first use

1. Remove clear base

- Keep the cap closed.
- Press the safety catch while firmly pulling off the clear base with your other hand.



<p>2. Insert cartridge</p> <ul style="list-style-type: none">• Insert the narrow end of the cartridge into the inhaler.• Place the inhaler on a firm surface and push down firmly until it clicks into place.• Do not remove the cartridge once it has been inserted into the inhaler.	 <p>The diagram illustrates the process of inserting the cartridge. On the left, a hand holds the inhaler and a separate cartridge. An upward arrow indicates the inhaler is being moved towards the cartridge. On the right, the inhaler is shown being pushed down onto a surface. A downward arrow points to the top of the inhaler. The word "CLICK" is written in a box next to the inhaler, indicating the sound of the cartridge locking in place.</p>
<p>3. Replace clear base</p> <ul style="list-style-type: none">• Put the clear base back into place until it clicks.• Do not remove the clear base again.	 <p>The diagram shows a hand holding the inhaler and another hand holding a clear base. An arrow points from the clear base towards the inhaler. The words "CLEAR BASE" are written next to the clear base.</p>
<p>4. Turn</p> <ul style="list-style-type: none">• Keep the cap closed.• Turn the clear base in the direction of the arrows on the label until it clicks (half a turn).	 <p>The diagram shows a hand holding the inhaler and another hand turning the clear base. An arrow points to the label on the clear base. The word "ARROWS" is written next to the label.</p>
<p>5. Open</p> <ul style="list-style-type: none">• Open the cap until it snaps fully open	 <p>The diagram shows a hand holding the inhaler and another hand opening the cap. An arrow points to the cap. The word "CAP" is written next to the cap.</p>

<p>6. Press</p> <ul style="list-style-type: none">• Point the inhaler toward the ground• Press the dose-release button.• Close the cap.• Repeat steps 4-6 until a cloud is visible.• After a cloud is visible, repeat steps 4-6 three more times. <p>Your inhaler is now ready to use. These steps will not affect the number of doses available. After preparation your inhaler will be able to deliver 120 puffs (120 doses).</p>	
---	--

Daily use

<p>TURN</p> <ul style="list-style-type: none">• Keep the cap closed.• TURN the clear base in the direction of the arrows on the label until it clicks (half a turn).	
---	---

<p>OPEN</p> <ul style="list-style-type: none">• OPEN the cap until it snaps fully open.	
---	--

PRESS

- Breathe out slowly and fully.
- Close your lips around the mouthpiece without covering the air vents. Point your Inhaler to the back of your throat.
- While taking a slow, deep breath through your mouth, **PRESS** the dose-release button and continue to breathe in slowly for as long as comfortable.
- Hold your breath for 10 seconds or for as long as comfortable.
- Close the cap until you use your inhaler again.

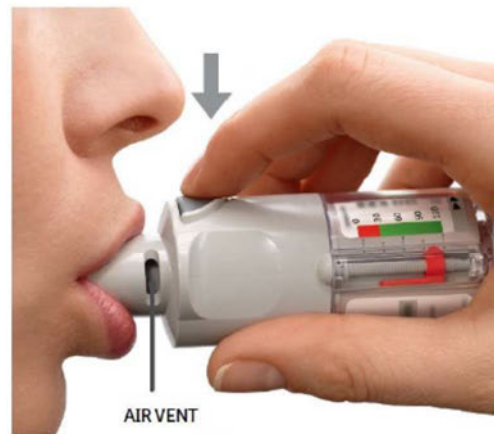

Appendix B Regulatory, Ethical and Study Oversight Considerations

B 1 Regulatory and ethical considerations

This study will be conducted in accordance with the protocol and with the following:

- Consensus ethical principles derived from international guidelines including the Declaration of Helsinki and Council for International Organizations of Medical Sciences (CIOMS) International Ethical Guidelines
- Applicable International Conference of Harmonisation (ICH) Good Clinical Practice (GCP) Guidelines
- Applicable laws and regulations

The protocol, protocol amendments, ICF, Investigator Brochure, and other relevant documents (e.g., advertisements) must be submitted to an Institutional Review Board (IRB)/Independent Ethics Committee (IEC) by the Investigator and reviewed and approved by the IRB/IEC before the study is initiated.

Any amendments to the protocol will require IRB/IEC approval before implementation of changes made to the study design, except for changes necessary to eliminate an immediate hazard to study subjects.

The Investigator will be responsible for the following:

- Providing written summaries of the status of the study to the IRB/IEC annually or more frequently in accordance with the requirements, policies, and procedures established by the IRB/IEC
- Notifying the IRB/IEC of SAEs or other significant safety findings as required by IRB/IEC procedures
- Providing oversight of the conduct of the study at the site and adherence to requirements of 21 Code of Federal Regulation (CFR), ICH guidelines, the IRB/IEC, European regulation 536/2014 for clinical studies (if applicable), and all other applicable local regulations

The study will be performed in accordance with the AstraZeneca policy on Bioethics and Human Biological Samples.

B 2 Regulatory Reporting Requirements for SAEs

Prompt notification by the investigator to the sponsor of a SAE is essential so that legal obligations and ethical responsibilities towards the safety of participants and the safety of a study intervention under clinical investigation are met.

The sponsor has a legal responsibility to notify both the local regulatory authority and other regulatory agencies about the safety of a study intervention under clinical investigation. The sponsor will comply with country-specific regulatory requirements relating to safety reporting to the regulatory authority, Institutional Review Boards (IRB)/Independent Ethics Committees (IEC), and investigators.

For all studies except those utilizing medical devices investigator safety reports must be prepared for suspected unexpected serious adverse reactions (SUSAR) according to local regulatory requirements and sponsor policy and forwarded to investigators as necessary.

An investigator who receives an investigator safety report describing a SAE or other specific safety information (e.g., summary or listing of SAEs) from the sponsor will review and then file it along with the Investigator's Brochure or and will notify the IRB/IEC, if appropriate according to local requirements.

B 3 Financial disclosure

Investigators and sub-Investigators will provide the Sponsor with sufficient, accurate financial information as requested to allow the Sponsor to submit complete and accurate financial certification or disclosure statements to the appropriate regulatory authorities. Investigators are responsible for providing information on financial interests during the course of the study and for 1 year after completion of the study.

B 4 Informed consent process

The Investigator or his/her representative will explain the nature of the study to the subject or his/her legally authorised representative and answer all questions regarding the study.

Subjects must be informed that their participation is voluntary. Subjects or their legally authorized representative will be required to sign a statement of informed consent that meets the requirements of 21 CFR 50, local regulations, ICH guidelines, Health Insurance Portability and Accountability Act (HIPAA) requirements, where applicable, and the IRB/IEC or study centre.

The medical record must include a statement that written informed consent was obtained before the subject was enrolled in the study and the date the written consent was obtained. The authorised person obtaining the informed consent must also sign the ICF.

Subjects must be re-consented to the most current version of the ICF(s) during their participation in the study.

A copy of the ICF(s) must be provided to the subject or the subject's legally authorised representative.

B 5 Data protection

Each subject will be assigned a unique identifier by the Sponsor. Any subject records or data sets transferred to the Sponsor will contain only the identifier; subject names or any information which would make the subject identifiable will not be transferred.

The subject must be informed that his/her personal study-related data will be used by the Sponsor in accordance with local data protection law. The level of disclosure must also be explained to the subject.

The subject must be informed that his/her medical records may be examined by Clinical Quality Assurance auditors or other authorised personnel appointed by the Sponsor, by appropriate IRB/IEC members, and by inspectors from regulatory authorities.

B 6 Committees structure

Not applicable

B 7 Dissemination of clinical study data

A description of this clinical trial will be available on <http://astrazenecaclinicaltrials.com> and <http://www.clinicaltrials.gov> as will the summary of the study results when they are available. The clinical trial and/or summary of study results may also be available on other websites according to the regulations of the countries in which the study is conducted.

B 8 Data quality assurance

All subject data relating to the study will be recorded on eCRF unless transmitted to the Sponsor or designee electronically (e.g., laboratory data). The Investigator is responsible for verifying that data entries are accurate and correct by electronically signing the eCRF.

The Investigator must maintain accurate documentation (source data) that supports the information entered in the eCRF.

The Investigator must permit study-related monitoring, audits, IRB/IEC review, and regulatory agency inspections and provide direct access to source data documents.

The Sponsor or designee is responsible for the data management of this study including quality checking of the data.

Study monitors will perform ongoing source data verification to confirm that data entered into the eCRF by authorized site personnel are accurate, complete, and verifiable from source documents; that the safety and rights of subjects are being protected; and that the study is being conducted in accordance with the currently approved protocol and any other study agreements, ICH GCP, and all applicable regulatory requirements.

Records and documents, including signed ICFs, pertaining to the conduct of this study must be retained by the Investigator for 15 years after study completion unless local regulations or

institutional policies require a longer retention period. No records may be destroyed during the retention period without the written approval of the Sponsor. No records may be transferred to another location or party without written notification to the Sponsor.

B 9 Source documents

Source documents provide evidence for the existence of the subject and substantiate the integrity of the data collected. Source documents are filed at the Investigator's site.

Data reported on the eCRF that are transcribed from source documents must be consistent with the source documents or the discrepancies must be explained. The Investigator may need to request previous medical records or transfer records, depending on the study. Also, current medical records must be available.

B 10 Publication policy

The results of this study may be published or presented at scientific meetings. If this is foreseen, the Investigator agrees to submit all manuscripts or abstracts to the Sponsor before submission. This allows the Sponsor to protect proprietary information and to provide comments.

The Sponsor will comply with the requirements for publication of study results. In accordance with standard editorial and ethical practice, the Sponsor will generally support publication of multicentre studies only in their entirety and not as individual site data. In this case, a coordinating Investigator will be designated by mutual agreement.

Authorship will be determined by mutual agreement and in line with International Committee of Medical Journal Editors authorship requirements.

Appendix C Instructions for Use of Ventolin HFA

Instructions for Use

For Oral Inhalation Only

Your VENTOLIN HFA inhaler

- The metal canister holds the medicine. See **Figure A**.

Figure A

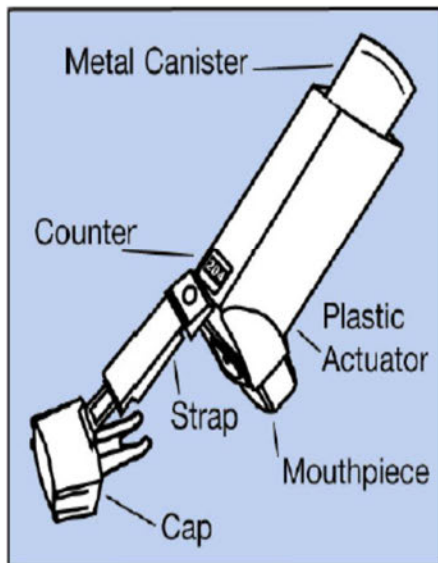

Figure A

The canister has a counter to show how many sprays of medicine you have left. The number shows through a window in the back of the actuator. See **Figure B**.

Figure B

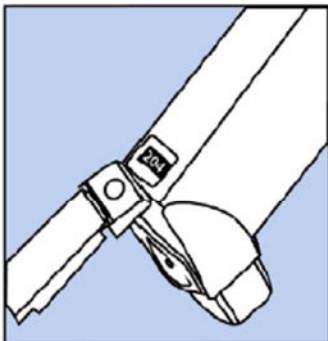

Figure B

- The counter starts at either **204** or **064**, depending on which size inhaler you have. The number will count down by 1 each time you spray the inhaler. The counter will stop counting at **000**.
- Do not try to change the numbers or take the counter off the metal canister. The counter cannot be reset, and it is permanently attached to the canister.
- The blue plastic actuator sprays the medicine from the canister. The actuator has a protective cap that covers the mouthpiece. **See Figure A.** Keep the protective cap on the mouthpiece when the canister is not in use. The strap keeps the cap attached to the actuator.
- **Do not** use the actuator with a canister of medicine from any other inhaler.
- **Do not** use a VENTOLIN HFA canister with an actuator from any other inhaler.

Before using your VENTOLIN HFA inhaler

Before you use VENTOLIN HFA for the first time, you must prime the inhaler so that you will get the right amount of medicine when you use it.

To prime the inhaler, take the cap off the mouthpiece and shake the inhaler well. Then spray the inhaler 1 time into the air away from your face. **See Figure C. Avoid spraying in eyes.**

Figure C

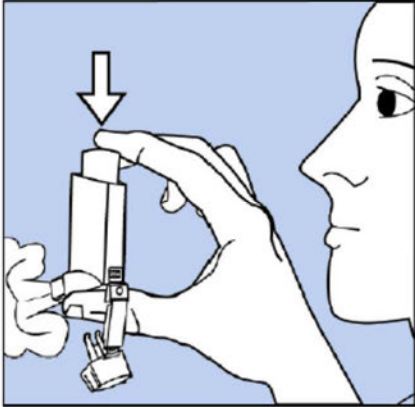

Figure C

- Shake and spray the inhaler like this 3 more times to finish priming it. The counter should now read **200** or **060**, depending on which size inhaler you have. **See Figure D.**

Figure D

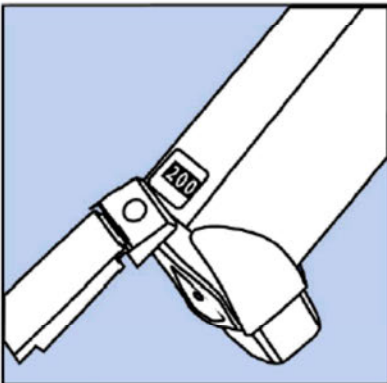

Figure D

You must prime your inhaler again if you have not used it in more than 14 days or if you drop it. Take the cap off the mouthpiece and shake and spray the inhaler 4 times into the air away from your face.

How to use your VENTOLIN HFA inhaler

Follow these steps every time you use VENTOLIN HFA.

Step 1. Make sure the canister fits firmly in the actuator. The counter should show through the window in the actuator.

Shake the inhaler well before each spray.

Take the cap off the mouthpiece of the actuator. Look inside the mouthpiece for foreign objects, and take out any you see.

Step 2. Hold the inhaler with the mouthpiece down. **See Figure E.**

Figure E

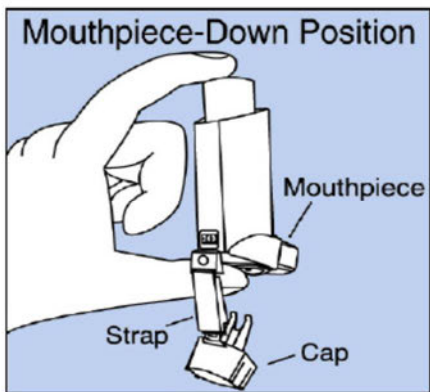

Figure E

Step 3. Breathe out through your mouth and push as much air from your lungs as you can. Put the mouthpiece in your mouth and close your lips around it. **See Figure F.**

Figure F

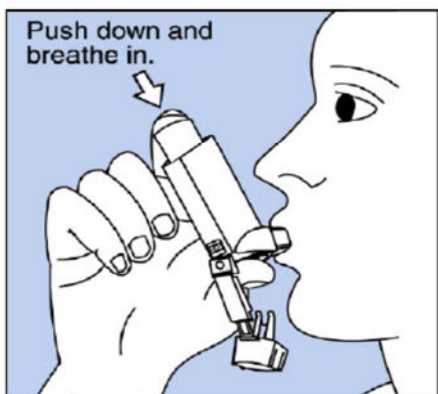

Figure F

Step 4. Push the top of the canister **all the way down** while you breathe in deeply and slowly through your mouth. **See Figure F.**

Step 5. After the spray comes out, take your finger off the canister. After you have breathed in all the way, take the inhaler out of your mouth and close your mouth.

Step 6. **Hold your breath for about 10 seconds**, or for as long as is comfortable. **Breathe out slowly as long as you can.**

If your healthcare provider has told you to use more sprays, wait 1 minute and shake the inhaler again. Repeat Steps 2 through Step 6.

Step 7. Put the cap back on the mouthpiece after every time you use the inhaler. Make sure it snaps firmly into place.

Cleaning your VENTOLIN HFA inhaler

Clean your inhaler at least 1 time each week. You may not see any medicine build-up on the inhaler, but it is important to keep it clean so medicine build-up will not block the spray. **See Figure G.**

Figure G

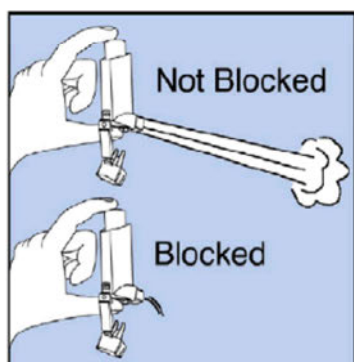

Figure G

Step 8. Take the canister out of the actuator, and take the cap off the mouthpiece. The strap on the cap will stay attached to the actuator.

Step 9. Hold the actuator under the faucet and run warm water through it for about 30 seconds. **See Figure H.**

Figure H

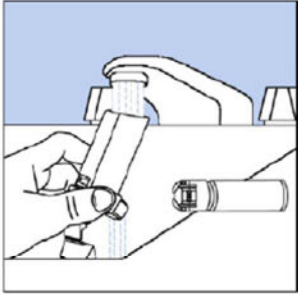

Figure H

Step 10. Turn the actuator upside down and run warm water through the mouthpiece for about 30 seconds. **See Figure I.**

Figure I

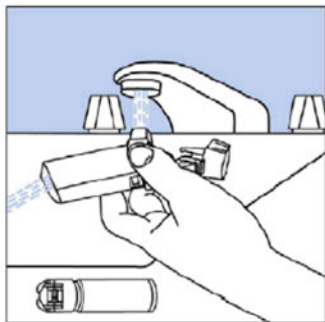

Figure I

Step 11. Shake off as much water from the actuator as you can. Look into the mouthpiece to make sure any medicine build-up has been completely washed away. If there is any build-up, repeat Steps 9 and 10.

Step 12. Let the actuator air-dry overnight. **See Figure J.**

Figure J

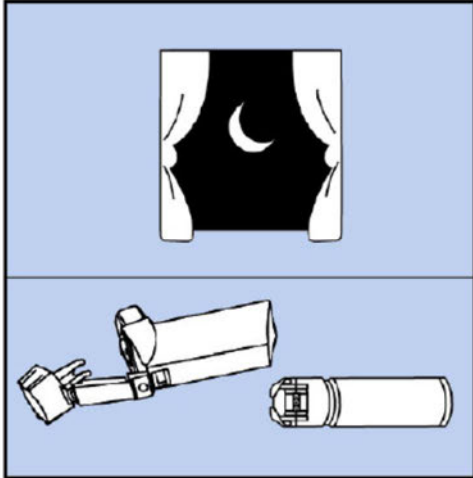

Figure J

Step 13. When the actuator is dry, put the protective cap on the mouthpiece and then put the canister in the actuator and make sure it fits firmly. Shake the inhaler well, remove the cap, and spray the inhaler once into the air away from your face. (The counter will count down by 1 number.) Put the cap back on the mouthpiece.

If you need to use your inhaler before the actuator is completely dry:

- Shake as much water off the actuator as you can.
- Put the cap on the mouthpiece and then put the canister in the actuator and make sure it fits firmly.
- Shake the inhaler well and spray it 1 time into the air away from your face.
- Take your VENTOLIN HFA dose as prescribed.
- Follow cleaning Steps 8 through 13 above.

Replacing your VENTOLIN HFA inhaler:

- **When the counter reads 020, you should refill your prescription or ask your healthcare provider if you need another prescription for VENTOLIN HFA.**
- **Throw the inhaler away when the counter reads 000 or 12 months after you opened the foil pouch, whichever comes first. You should not keep using the inhaler when the counter reads 000 because you will not receive the right amount of medicine.**

- **Do not use the inhaler** after the expiration date, which is on the packaging it comes in.

For correct use of your VENTOLIN HFA inhaler, remember:

- The canister should always fit firmly in the actuator.
- Breathe in deeply and slowly to make sure you get all the medicine.
- Hold your breath for about 10 seconds after breathing in the medicine. Then breathe out fully.
- Always keep the protective cap on the mouthpiece when your inhaler is not in use.
- Always store your inhaler with the mouthpiece pointing down.
- Clean your inhaler at least 1 time each week.

If you have questions about VENTOLIN HFA or how to use your inhaler, call GlaxoSmithKline (GSK) PPD or visit www.ventolin.com.

This Patient Information and Instructions for Use have been approved by the U.S. Food and Drug Administration.

VENTOLIN is a registered trademark of the GSK group of companies.
GlaxoSmithKline

PPD NC 27709















©2014, the GSK group of companies. All rights reserved.

December 2014

VNT:9PIL

Appendix D Dose Indicator Display Reading Instructions

For the purposes of this study, when recording the dose indicator display value, review the indicator display at the top of the MDI and record the number of inhalations remaining that matches the chart below:

130 Count (Actuation) Version Shown				
 <p>If your dose indicator display looks like this record 120+</p>	 <p>If your dose indicator display looks like this record 120</p>	 <p>If your dose indicator display looks like this record 110</p>	 <p>If your dose indicator display looks like this record 100</p>	 <p>If your dose indicator display looks like this record 90</p>
 <p>If your dose indicator display looks like this record 80</p>	 <p>If your dose indicator display looks like this record 70</p>	 <p>If your dose indicator display looks like this record 60</p>	 <p>If your dose indicator display looks like this record 50</p>	 <p>If your dose indicator display looks like this record 40</p>
 <p>If your dose indicator display looks like this record 30</p>	 <p>If your dose indicator display looks like this record 20</p>	 <p>If your dose indicator display looks like this record 10</p>	 <p>If your dose indicator display looks like this record 0</p>	

Appendix E Subject Instructions for Use of BFF MDI and Budesonide MDI

How do I store the Inhaler?

- The inhaler should be stored below 25°C (77°F) in a dry place. Excursions permitted up to 30°C (86°F).
- The contents of the canister are under pressure. Do not puncture or throw the canister into a fire or incinerator. Do not use or store it near heat or open flame. Storage above 120°F may cause the canister to burst.
- **Keep the product and all medicines out of the reach of children.**

For Oral Inhalation Only

Parts of the Inhaler:

- The parts of your inhaler are seen in **Figure 1**.

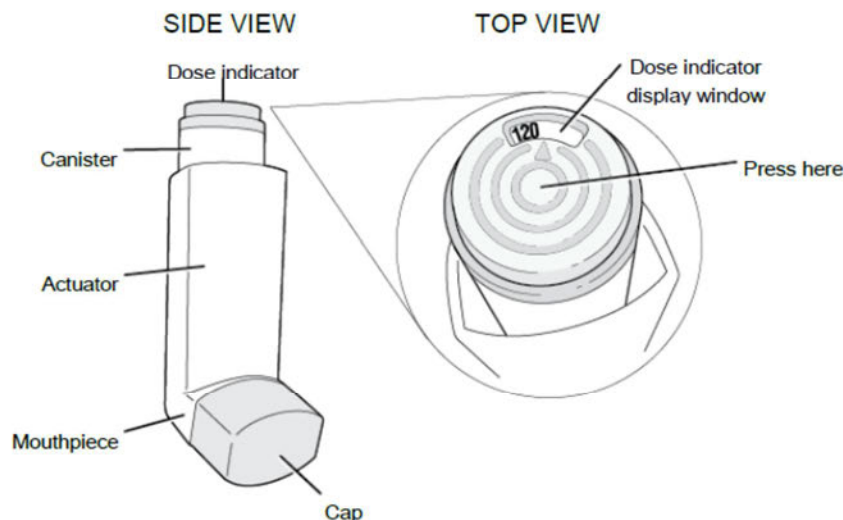

Figure 1

- The **Dose indicator** lets you know about how many puffs are left in your inhaler and is the part of the inhaler that is pressed to dispense a puff of medication. **See Figure 1.**
- The **Dose indicator** should be pointing just to the right of 120 when your inhaler is new. **See Figure 1.**
- The **Dose indicator** has numbers for every 20 puffs. The **Dose indicator** display will move after every tenth puff.
- For example, if the **Dose indicator** is pointing to 120 (**see Figure 2a**) and you take 10 puffs it will move between 120 and 100. This means that there

are 110 puffs of medicine left (**see Figure 2b**). After 10 more puffs are used, the **Dose indicator** pointer will move to the number 100. This means that there are 100 puffs of medicine left (**see Figure 2c**).



Figure 2a
120 puffs



Figure 2b
110 puffs



Figure 2c
100 puffs

- The **Dose indicator** number will continue to change after every 20 puffs.
- When the number in the **Dose indicator** window changes to 20 and the color behind the number changes to red, this means that there are only 20 puffs left in your inhaler. **See Figure 2d.**



Figure 2d

Preparing the Inhaler for Use:

The inhaler comes in a foil pouch that contains a drying packet (desiccant).

- Take the inhaler out of the foil pouch.
- Throw away the pouch and the drying packet. Do not eat or inhale the contents of the drying packet.
- Remove the **Cap** from the **Mouthpiece** as shown in **Figure 3**.

Figure 3

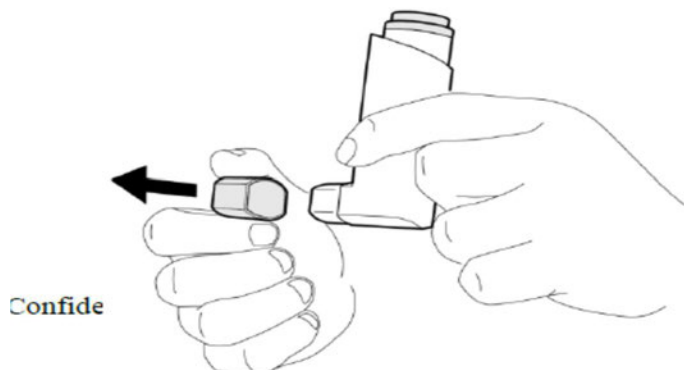

Prime the inhaler before you use it for the first time.

Priming the Inhaler:

- Check inside the **Mouthpiece** for objects before use.
- Hold the **Actuator** with the **Mouthpiece** pointing away from you and others as shown in **Figure 4a**.
- Shake the inhaler well before each puff.
- Push down fully on the center (not 'off center') of the **Dose indicator** on top of the **Canister** (see **Figure 1**) until the **Canister** stops moving in the **Actuator** to release a puff from the **Mouthpiece** as shown in **Figure 4b**.
Note: It is normal to hear a soft click from the dose indicator as it counts down during use.
- Repeat this priming step 3 more times for a total of 4 times, shaking the inhaler each time before you press it.
- After completing the 4 priming puffs, your inhaler is now primed ready to use for the first time.

You must re-prime your inhaler again if you have not used it in more than 7 days. Take the cap off the mouthpiece and shake and spray the inhaler 2 times into the air away from your face.

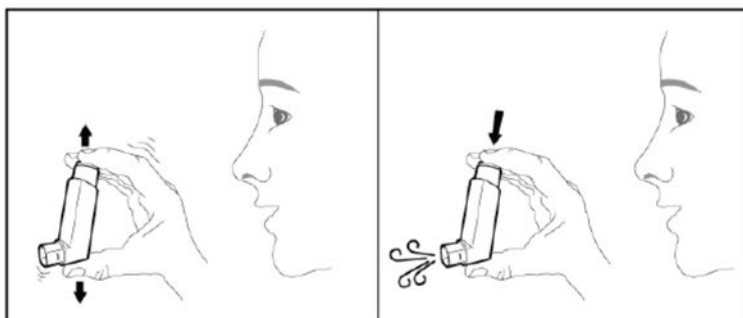

Figure 4a

Figure 4b

Using the Inhaler:

Your dose of medicine comes from **2 puffs** from the inhaler. Refer to **Figure 5** for Step 1 through Step 8.

- **Step 1:** Remove the **Cap** from the **Mouthpiece**.
- **Step 2:** Shake the inhaler well before each puff.

- **Step 3:** While holding the inhaler with the **Mouthpiece** pointing towards you breathe out through your mouth to empty as much air from your lungs as possible.
- **Step 4:** Close your lips around the **Mouthpiece** and tilt your head back slightly to make sure your tongue is away from the **Mouthpiece**.
- **Step 5:** Take a deep breath in (inhale) slowly through your mouth while pressing down firmly on the center (not 'off center') of the **Dose indicator** until the **Canister** stops moving in the **Actuator** and a puff has been released. Then, stop pressing the **Dose indicator**.
- **Step 6:** When you have finished breathing in, remove the **Mouthpiece** from your mouth and hold your breath for 10 seconds or as long as comfortable.
- **Step 7:** Then, breathe out normally.

Take your second puff of medicine by repeating Step 2 through Step 7.

- **Step 8:** Replace the **Cap** back on the **Mouthpiece**.
- **Step 9:** Rinse your mouth with water after your daily dosing in the morning and/or evening and spit it out

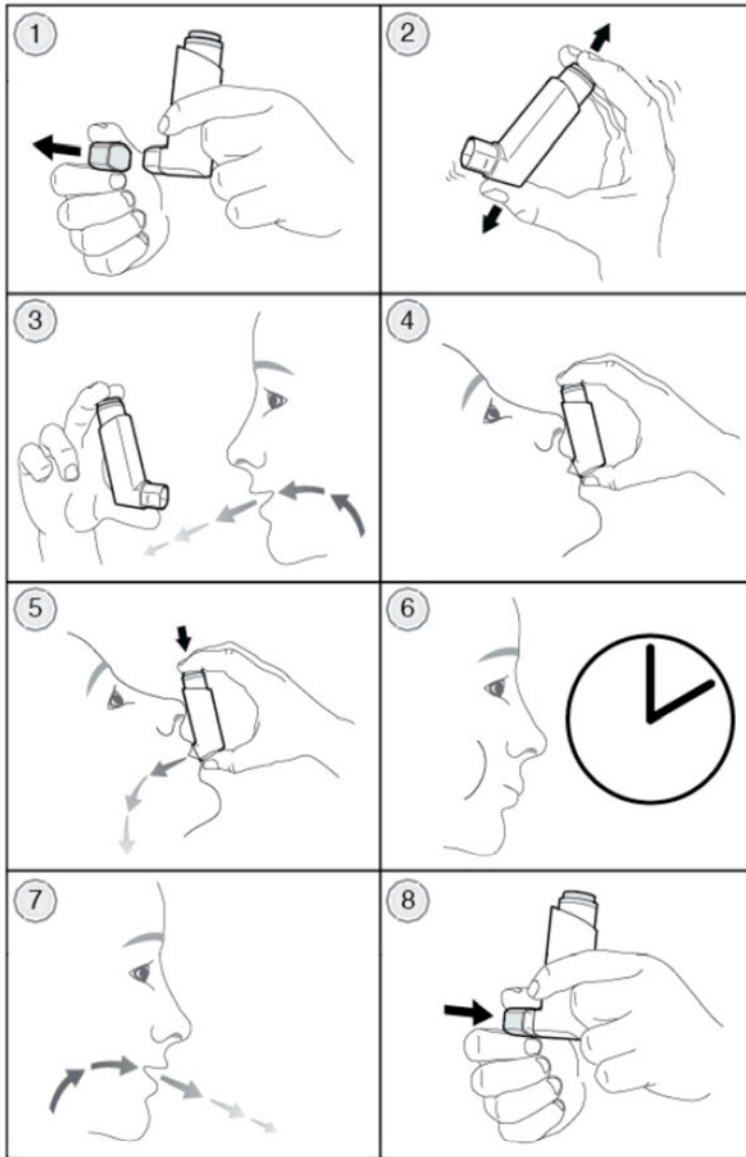

Figure 5

How to clean the Inhaler:

It is very important to keep your inhaler clean so medicines will not build-up and block the spray through the **Mouthpiece**. See **Figure 6**.

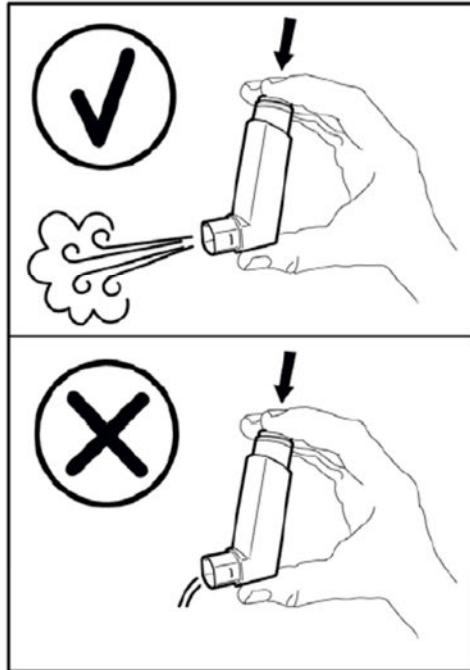
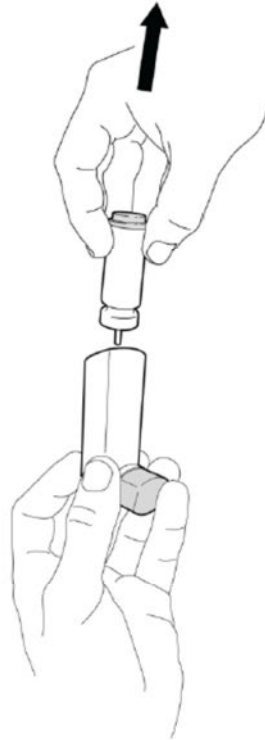

Figure 6

The **Canister** should be gently pulled from the top of the **Actuator** once a week and the **Actuator** cleaned. **Do not clean the Canister or let it get wet.**

- **Step 1:** Pull the **Canister** out of the **Actuator** as shown in **Figure 7**.

Figure 7



- **Step 2:** Set the **Canister** aside where it will not get wet.
- **Step 3:** Take the **Cap** off the **Mouthpiece**.
- **Step 4:** Rinse the **Actuator** through the top with warm running water for 30 seconds. Then rinse the actuator again through the Mouthpiece (see **Figure 8**).

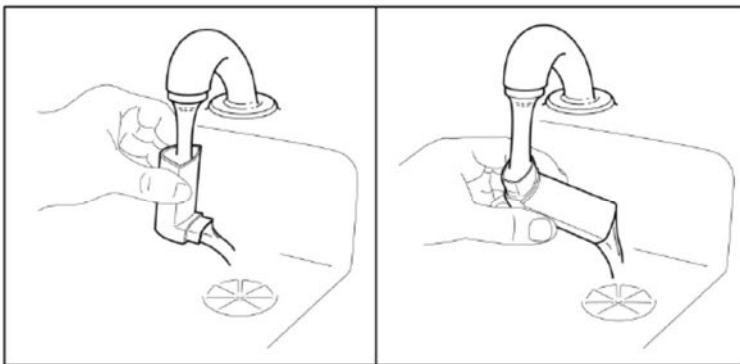

Figure 8

- **Step 5:** Shake all of the water droplets out of the **Actuator**.

- **Step 6:** Look in the **Actuator** and the **Mouthpiece** to make sure it is clean and clear.

Repeat **Step 4** through **Step 6**, until the **Actuator** and the **Mouthpiece** are clean and clear.

- **Step 7:** Let the **Actuator** dry completely, such as overnight as shown in **Figure 9**. **Do Not** put the **Canister** back into the **Actuator** if it is still wet.

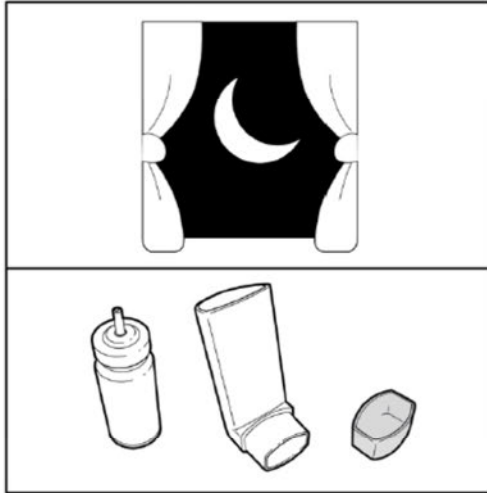

Figure 9

Reassembly of the Inhaler and Instructions for Use after Cleaning:

- After the **Actuator** is completely dry, gently press the **Canister** down in the **Actuator** as shown in **Figure 10**. It is not necessary to press down on the **Canister** hard enough to cause a puff to be released.

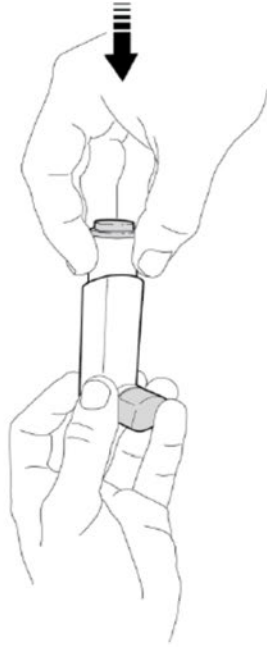

Figure 10

- Re-prime your inhaler 2 times after each cleaning.
- Hold the **Actuator** with the **Mouthpiece** pointing away from you and others as shown in **Figure 4**.
- Shake the inhaler well before each puff.
- Push down fully on the center (not 'off center') of the **Dose indicator** on top of the **Canister** until the **Canister** stops moving in the **Actuator** to release a puff from the **Mouthpiece**.
- Repeat this re-priming step 1 more time for a total of 2 times.
- After re-priming your inhaler 2 times, your inhaler is now ready to use.

Appendix F Instructions for Use of Symbicort Turbuhaler Inhalation Powder Device

Preparing your new Symbicort Turbuhaler

Before using your **new** Symbicort Turbuhaler **for the first time**, you need to prepare it for use as follows:

- Unscrew the cover and lift it off. You may hear a rattling sound.
- Hold your Turbuhaler upright with the red grip at the bottom.
- Turn the red grip as far as it will go in one direction. Then turn it as far as it will go in the other direction (it does not matter which way you turn it first). You should hear a click sound.



- Do this again, turning the red grip in both directions.
- Your Turbuhaler is now ready for use.

How to take an inhalation

Every time you need to take an inhalation, follow the instructions below.

1. Unscrew the cover and lift it off. You may hear a rattling sound.
2. Hold your Turbuhaler upright with the red grip at the bottom.
3. Do not hold the mouthpiece when you load your Turbuhaler. To load your Turbuhaler with a dose, turn the red grip as far as it will go in one direction. Then turn it as far as it will go in the other direction (it does not matter which way you turn it first). You should hear a click sound. Your Turbuhaler is now loaded and ready to use. Only load your Turbuhaler when you need to use it.
4. Hold your Turbuhaler away from your mouth. Breathe out gently (as far as is comfortable). Do not breathe out through your Turbuhaler.
5. Place the mouthpiece gently between your teeth. Close your lips. Breathe in as deeply and as hard as you can through your mouth. Do not chew or bite on the mouthpiece.



6. Remove your Turbohaler from your mouth. Then breathe out gently. The amount of medicine that is inhaled is very small. This means you may not be able to taste it after inhalation. If you have followed the instructions, you can still be confident that you have inhaled the dose and the medicine is now in your lungs.



7. If you are to take a second inhalation, repeat steps 2 to 6.
8. Replace the cover tightly after use.
9. Rinse your mouth with water after your daily morning and/or evening doses, and spit it out.

Do not try to remove or twist the mouthpiece. It is fixed to your Turbohaler and must not be taken off. Do not use your Turbohaler if it has been damaged or if the mouthpiece has come apart from your Turbohaler.

Cleaning your Turbohaler

Wipe the outside of the mouthpiece once a week with a dry tissue. Do not use water or liquids.

How to store Symbicort Turbohaler

- Keep this medicine out of the sight and reach of children.
- Do not use this medicine after the expiry date that is stated on the carton or on the label of your inhaler after EXP. The expiry date refers to the last day of that month.
- Do not store above 30°C.
- Keep the container/cap tightly closed, in order to protect from moisture.
- Do not throw away any medicines via wastewater or household waste. Ask your pharmacist how to throw away medicines you no longer use. These measures will help protect the environment.

Appendix G Instructions for Use of AeroChamber PlusFlow Vu



AeroChamber PlusFlow Vu
 Anti-Static Valved Holding Chamber
 MOUTHPIECE / LARGE MASK











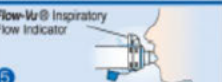

INDICATIONS FOR USE
 This product is intended to be used by patients who are under the care or treatment of a physician or licensed healthcare professional. The device is intended to be used by these patients to administer aerosolized medication from most pressurized Metered Dose Inhalers. The intended environments for use include the home, hospitals and clinics.

Small Mask Medium Mask Mouthpiece Large Mask

This device has not been made (or manufactured) with 52% Disinfectant VU or LUCS.

Distributed by:
FOREST PHARMACEUTICALS, INC.
 Subsidiary of Forest Laboratories, LLC
 Monaghan Medical Corporation, PPD
 PPD Pittsburgh, NY PPD

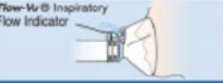
INSTRUCTIONS FOR USE
 THIS PRODUCT CAN BE USED RIGHT OUT OF PACKAGE. BEFORE USE, ENSURE THESE INSTRUCTIONS AND THE INSTRUCTIONS SUPPLIED WITH THE METERED DOSE INHALER (MDI) HAVE BEEN READ.

MOUTHPIECE	 1 Carefully examine the product for damage, missing parts or foreign objects prior to use. The product should be replaced IMMEDIATELY if there are any damaged or missing parts. If necessary, use the Metered Dose Inhaler (MDI) alone until a replacement is obtained. If the patient's symptoms worsen, please seek immediate medical attention.	 2 Remove cap(s) from the MDI and chamber (if applicable).	 3 Shake the MDI immediately before each use as per the instructions supplied with the MDI.	 4 Insert the MDI into the Backpiece of the chamber.	 5 Put mouthpiece into mouth and close lips around it to ensure an effective seal. The Flow-Vu® Inspiratory Flow Indicator (IFI) only moves if the patient has a good seal. Apply mask to face and ensure an effective seal. The Flow-Vu® Inspiratory Flow Indicator only moves if a good seal is created.	 6 Breathe out gently and press the MDI at the beginning of a slow inhalation. Use the Flow-Vu® IFI to assist in the coordination of this step. Breathe in slowly and deeply through the mouth until a full breath has been taken. Hold breath for 5 – 10 seconds, if possible. Otherwise, keep lips tight on the mouthpiece breathing normally 2 – 3 times through the chamber after the MDI is pressed. Slow down inhalation if you hear the FlowSignal® Whistle sound. It means you are inhaling too quickly. Administer one (1) puff at a time. Breathe out gently and press the MDI at the beginning of a slow inhalation as the Flow-Vu® IFI moves towards you. Use the Flow-Vu® IFI to count breaths. Maintain seal for 5 – 6 breaths after the MDI is pressed. Slow down inhalation if you hear the FlowSignal® Whistle sound. It means you are inhaling too quickly. Administer one (1) puff at a time.	 7 Follow instructions supplied with the MDI on how long to wait before repeating steps 3 – 6 as prescribed.
	LARGE MASK	 1 Carefully examine the product for damage, missing parts or foreign objects prior to use. The product should be replaced IMMEDIATELY if there are any damaged or missing parts. If necessary, use the Metered Dose Inhaler (MDI) alone until a replacement is obtained. If the patient's symptoms worsen, please seek immediate medical attention.	 2 Remove cap(s) from the MDI and chamber (if applicable).	 3 Shake the MDI immediately before each use as per the instructions supplied with the MDI.	 4 Insert the MDI into the Backpiece of the chamber.	 5 Put mask on face and ensure an effective seal. The Flow-Vu® Inspiratory Flow Indicator (IFI) only moves if the patient has a good seal. Apply mask to face and ensure an effective seal. The Flow-Vu® Inspiratory Flow Indicator only moves if a good seal is created.	 6 Breathe out gently and press the MDI at the beginning of a slow inhalation. Use the Flow-Vu® IFI to assist in the coordination of this step. Breathe in slowly and deeply through the mouth until a full breath has been taken. Hold breath for 5 – 10 seconds, if possible. Otherwise, keep lips tight on the mouthpiece breathing normally 2 – 3 times through the chamber after the MDI is pressed. Slow down inhalation if you hear the FlowSignal® Whistle sound. It means you are inhaling too quickly. Administer one (1) puff at a time. Breathe out gently and press the MDI at the beginning of a slow inhalation as the Flow-Vu® IFI moves towards you. Use the Flow-Vu® IFI to count breaths. Maintain seal for 5 – 6 breaths after the MDI is pressed. Slow down inhalation if you hear the FlowSignal® Whistle sound. It means you are inhaling too quickly. Administer one (1) puff at a time.

Notes:

- Storage and operating range 5° C - 40° C (41° F - 104° F) at 15 to 95% relative humidity
- Product may need to be replaced after 12 months of use. Environmental conditions, storage and proper cleaning can affect product life span.
- Do not share this medical device.
- If you notice medication build-up in your chamber, wash the inside of the chamber gently with a soft cloth.
- Dishwashing with overly dirty dishes is not recommended.
- Dishwasher validated up to 158°F (70°C).

CAUTIONS:

1. PRODUCT MAY BE PERMANENTLY DAMAGED IF BOILED, STERILIZED OR CLEANED IN A DISHWASHER AT TEMPERATURE ABOVE 158°F (70°C).
2. Do not leave the chamber unattended with children.
3. Federal (USA) law restricts the sale of this device on or by the order of a physician.

Rx Only

Appendix H Spirometry Performance Recommendations

Spirometry data of the highest quality must be obtained for proper interpretation of the results of this protocol. To this end, a standard spirometer will be used (provided by ERT), central training provided, qualification will be required, and specific operating instruction will be provided.

FEV₁ and FVC Maneuvers

Equipment Requirements

The spirometer must be capable of accumulating volume for >15 s (longer times are recommended) and measuring volumes of >8 L (body temperature (i.e., 37°C), ambient pressure, saturated with water vapor, BTPS) with an accuracy of at least +3% of reading or +0.050 L, whichever is greater, with flows between 0 and 14 L-s⁻¹. The total resistance to airflow at 14.0 L-s⁻¹ must be <1.5 cmH₂O L-s⁻¹ (0.15 kPa L-s⁻¹). The total resistance must be measured with any tubing, valves, pre-filter, etc. included that may be inserted between the subject and the spirometer. Some devices may exhibit changes in resistance due to water vapor condensation, and accuracy requirements must be met under BTPS conditions for up to 8 successive FVC maneuvers performed in a 10-minute period without inspiration from the instrument.

Display

For optimal quality control, both flow–volume and volume–time displays are useful, and test operators should visually inspect the performance of each maneuver for quality assurance before proceeding with another maneuver. This inspection requires tracings to meet the minimum size and resolution requirements set forth in this standard. Displays of flow versus volume provide more detail for the initial portion (first 1 s) of the FVC maneuver. Since this portion of the maneuver, particularly the peak expiratory flow (PEF), is correlated with the pleural pressure during the maneuver, the flow–volume display is useful to assess the magnitude of effort during the initial portions of the maneuver. The ability to overlay a series of flow–volume curves registered at the point of maximal inhalation may be helpful in evaluating repeatability and detecting sub-maximal efforts. However, if the point of maximal inhalation varies between blows, then the interpretation of these results is difficult because the flows at identical measured volumes are being achieved at different absolute lung volumes. In contrast, display of the FVC maneuver as a volume–time graph provides more detail for the latter part of the maneuver. A volume–time tracing of sufficient size also allows independent measurement and calculation of parameters from the FVC maneuvers. In a display of multiple studies, the sequencing of the blows should be apparent to the user. For the start of test display, the volume–time display should include >0.25 s, and preferably 1 s, before exhalation starts (zero volume). This time period before there is any change in volume is needed to calculate the back extrapolated volume (EV) and to evaluate effort during the initial portion of the maneuver. Time zero, as defined by EV, must be presented as the zero point on the graphical output. The last 2 s of the maneuver should be displayed to indicate a satisfactory end of test.

When a volume–time curve is plotted as hardcopy, the volume scale must be >10 mm L-1 (BTPS). For a screen display, 5 mm L-1 is satisfactory (Table A1-1).

Table A1-1. Recommended Minimal Scale Factors for Time, Volume and Flow on Graphical Output

Parameters	Instrument Display		Hardcopy Graphical
	Resolution Required	Scale Factor	Resolution Required
Volume*	0.050 L	5 mm-L ⁻¹	0.050 L
Flow*	0.200 L-s ⁻¹	2.5 mm L ⁻¹ s ⁻¹	0.200 L-s ⁻¹
Time	0.1 s	10 mm-s ⁻¹	0.2 s

*The correct aspect ratio for the flow versus display is two units of flow per one unit of volume

The time scale should be >20 mm-s-1, and larger time scales are preferred (>30 mm-s-1) when manual measurements are made. When the volume–time plot is used in conjunction with a flow–volume curve (i.e., both display methods are provided for interpretations and no hand measurements are performed), the time scale requirement is reduced to 10 mm-s-1 from the usually required minimum of 20 mm-s-1 (Table A1-1). The rationale for this exception is that the flow–volume curve can provide the means for quality assessment during the initial portion of the FVC maneuver. The volume–time curve can be used to evaluate the latter part of the FVC maneuver, making the time scale less critical.

Validation

It is strongly recommended that spirometry systems should be evaluated using a computer-driven mechanical syringe or its equivalent, in order to test the range of exhalations that are likely to be encountered in the test population. Testing the performance of equipment is not part of the usual laboratory procedures.

Quality Control

Attention to equipment quality control and calibration is an important part of Good Laboratory Practice. At a minimum, the requirements are as follows: 1) a log of calibration results is maintained; 2) the documentation of repairs or other alterations which return the equipment to acceptable operation; 3) the dates of computer software and hardware updates or changes; and 4) if equipment is changed or relocated (e.g., industrial surveys), calibration checks and quality-control procedures must be repeated before further testing begins.

Key aspects of equipment quality control are summarized in Table A1-2.

Table A1-2. Summary of Equipment Quality Control

Test	Minimal Interval	Action
Volume	Daily	Calibration check with a 3 L syringe
Leak	Daily	2 cm H ₂ O (0.3 kPa) constant pressure for 1 minute
Volume Linearity	Quarterly	1 L increments with a calibrating syringe measured over the entire volume range
Flow Linearity	Weekly	Test at least 3 different flow ranges
Time	Quarterly	Mechanical recorder check with stop watch
Software	New versions	Log installation date and perform test using “known” subject

Calibration is the procedure for establishing the relationship between sensor-determined values of flow or volume and the actual flow or volume. A calibration check is different from calibration and is the procedure used to validate that the device is within calibration limits, e.g., +3% of true. If a device fails its calibration check, then a new calibration procedure or equipment maintenance is required. Calibration checks must be undertaken daily, or more frequently, if specified by the manufacturer. The syringe used to check the volume calibration of spirometers must have an accuracy of +15 mL or +0.5% of the full scale (15 mL for a 3-L syringe), and the manufacturer must provide recommendations concerning appropriate intervals between syringe calibration checks. Users should be aware that a syringe with an adjustable or variable stop may be out of calibration if the stop is reset or accidentally moved. Calibration syringes should be periodically (e.g., monthly) leak tested at more than one volume up to their maximum; this can be done by attempting to empty them with the outlet corked. A dropped or damaged syringe should be considered out of calibration until it is checked.

With regard to time, assessing mechanical recorder time scale accuracy with a stopwatch must be performed at least quarterly. An accuracy of within 2% must be achieved.

Quality Control for Volume-Measuring Devices

The volume accuracy of the spirometer must be checked at least daily, with a single discharge of a 3-L calibrated syringe. Daily calibration checking is highly recommended so that the onset of a problem can be determined within 1 day, and also to help define day-to-day laboratory variability. More frequent checks may be required in special circumstances, such as: 1) during industrial surveys or other studies in which a large number of subject maneuvers are carried out, the equipment’s calibration should be checked more frequently than daily; and 2) when the ambient temperature is changing (e.g., field studies), volume accuracy must be checked more frequently than daily and the BTPS correction factor appropriately updated.

The accuracy of the syringe volume must be considered in determining whether the measured volume is within acceptable limits. For example, if the syringe has an accuracy of 0.5%, a reading of +3.5% is appropriate.

The calibration syringe should be stored and used in such a way as to maintain the same temperature and humidity of the testing site. This is best accomplished by keeping the syringe in close proximity to the spirometer, but out of direct sunlight and away from heat sources.

Volume-type spirometer systems must be evaluated for leaks every day. The importance of undertaking this daily test cannot be overstressed. Leaks can be detected by applying a constant positive pressure of >3.0 cmH₂O (0.3 kPa) with the spirometer outlet occluded (preferably at or including the mouthpiece). Any observed volume loss of 30 mL after 1 minute indicates a leak and needs to be corrected.

At least quarterly, volume spirometers must have their calibration checked over their entire volume range using a calibrated syringe or an equivalent volume standard. The measured volume should be within +3.5% of the reading or 65 mL, whichever is greater. This limit includes the 0.5% accuracy limit for a 3-L syringe. The linearity check procedure provided by the manufacturer can be used if it is equivalent to one of the following procedures: 1) consecutive injections of 1-L volume increments while comparing observed volume with the corresponding cumulative measured volume, e.g., 0–1, 1–2, 2–3, ... 6–7 and 7–8 L, for an 8-L spirometer; and 2) injection of a 3-L volume starting at a minimal spirometer volume, then repeating this with a 1-L increment in the start position, e.g., 0–3, 1–4, 2–5, 3–6, 4–7 and 5–8 L, for an 8-L spirometer. The linearity check is considered acceptable if the spirometer meets the volume accuracy requirements for all volumes tested.

Quality Control for Flow-Measuring Devices

With regards to volume accuracy, calibration checks must be undertaken at least daily, using a 3 L syringe discharged at least 3 times to give a range of flows varying between 0.5 and 12 L-s-1 (with 3-L injection times of 6 s and 0.5 s). The volume at each flow should meet the accuracy requirement of +3.5%. For devices using disposable flow sensors, a new sensor from the supply used for patient tests should be tested each day.

For linearity, a volume calibration check should be performed weekly with a 3-L syringe to deliver 3 relatively constant flows at a low flow, then 3 at a mid-range flow and finally 3 at a high flow. The volumes achieved at each of these flows should each meet the accuracy requirement of +3.5%.

VC Maneuvers

Equipment

For measurements of VC, the spirometer or flow meter must comply with the requirements for FVC (as described previously) and be capable of accumulating volume for >30 s. Expiratory

maneuvers or, ideally, both inspiratory and expiratory maneuvers should be included in the display of VC maneuver. Regardless of whether the inspiratory or expiratory maneuver is used for deriving measurements, a display of the entire recorded VC maneuver must be provided. The maximal expiratory volume must be assessed to determine whether the subject has obtained a plateau in the expiratory effort. For display of the slow VC, the time scale may be reduced to 5 mm-s-1.

Technical Considerations

Minimal recommendations for spirometry systems

Accurate results require accurate equipment. Spirometer equipment recommendations apply to all spirometers and are minimal requirements. In some circumstances, it may be appropriate to exceed these requirements (i.e., in some research/surveillance applications). Instrumentation recommendations should be followed to provide accurate spirometric data and information that is comparable from laboratory to laboratory and from one time period to another. The accuracy of a spirometry system depends on characteristics of the entire system, from the volume or flow transducer and the use of an in-line filter, to the recorder, display or processor. Changes in any aspect of the equipment or errors at any step in the process can affect the accuracy of the results. For example, if the BTPS correction factor is wrong, an accurately measured FVC will be incorrectly reported. Spirometers are not required to measure all of the indices in Table A1-3 but must meet the recommendations for those that are measured. Accuracy and repeatability recommendations apply over the entire volume range of the instrument.

Table A1-3. Range and Accuracy Recommendations Specified for Forced Expiratory Maneuvers

Test	Range/Accuracy (BTPS)	Flow Range (L-s ⁻¹)	Time (s)	Resistance and Back Pressure	Test Signal
VC	0.5–8 L, ±3% of reading or ±0.050 L, whichever is greater	0-14	30		3-L Calibration syringe
FVC	0.5–8 L, ±3% of reading or ±0.050 L, whichever is greater	0-14	15	<1.5 cm H ₂ O L ⁻¹ s ⁻¹ (0.15 kPa L ⁻¹ s ⁻¹)	24 ATS waveforms, 3-L Cal Syringe
FEV ₁	0.5–8 L, +3% of reading or ±0.050 L, whichever is greater	0-14	1	<1.5 cm H ₂ O L ⁻¹ s ⁻¹ (0.15 kPa L ⁻¹ s ⁻¹)	24 ATS waveforms
Time Zero	The time point from which all FEV _t measurements are taken.			Back extrapolation	

FEV_t: forced expiratory volume in t seconds

BTPS correction

All spirometry values should be reported at BTPS by any method (measuring temperature and barometric pressure) proven effective by the manufacturer. For volume-type spirometers, the temperature inside the spirometer should be measured for each breathing maneuver. Regardless of the BTPS correction technique used, the ambient temperature must always be recorded with an accuracy of $+1^{\circ}\text{C}$. In situations where the ambient air temperature is changing rapidly ($>3^{\circ}\text{C}$ in <30 min), continuous temperature corrections may be necessary. Spirometer users should be aware of potential problems with testing performed at lower ambient temperatures: 17°C is the lower limit for ambient temperature, unless a manufacturer states that their spirometer will operate accurately at lower ambient temperatures. If barometric pressure is not used in calculating the BTPS correction factor, the range of barometric pressures over which the BTPS correction factor is valid must be published.

Appendix I Spirometry Assessment Criteria

Acceptable Versus Usable Tests

Acceptable Tests must meet the following 7 Criteria:

1. Acceptable start of exhalation with brisk upstroke, no hesitation or false start, and back EV <5% of FVC or 0.150 L, whichever is the greater. (Refer to example in Figure A2-1)
2. No cough during the first second.
3. No Valsalva maneuver.
4. No leak.
5. No obstruction of mouthpiece.
6. No extra breaths.
7. Plateau achieved, i.e., the volume-time curve shows no change in volume (<0.025 L) for ≥ 1 second, and the patient has tried to exhale for at least 6 seconds.

An acceptable test meets all 7 criteria listed. This is to be considered the “gold standard”.

Usable spirometry tracings are those that only meet criteria 1 and 2. If only Usable tests are obtained, report results based on the 3 best Usable tests with observed limitations.

Pulmonary function tests will be limited to 3 attempts. Every effort should be made to get 3 reproducible and acceptable maneuvers; however, if this is not possible, the best of the 3 attempts will be recorded.

Figure A2-1. Example of a Usable Spirogram

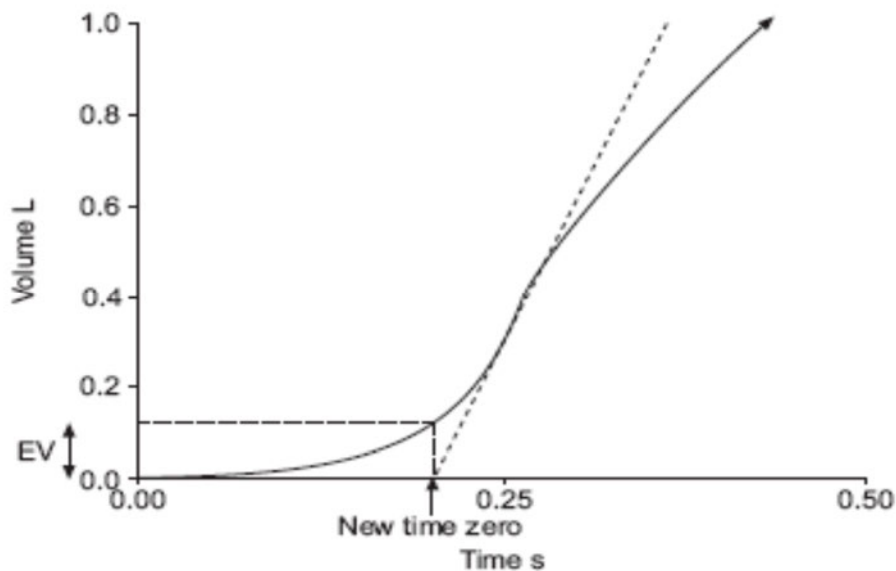

The expanded version of the early part of a subject's volume-time spirogram, illustrating back extrapolation through the steepest part of the curve, where flow is PEF, to determine the new "time zero". Forced vital capacity (FVC)-4.291 L; back extrapolated volume (EV) – 0.123 L (2.9% FVC): back extrapolation line through PEF.

Appendix J Instruction for Use of InCheck Inspiratory Flow Measurement Device

How to use the *In-Check DIAL G16*

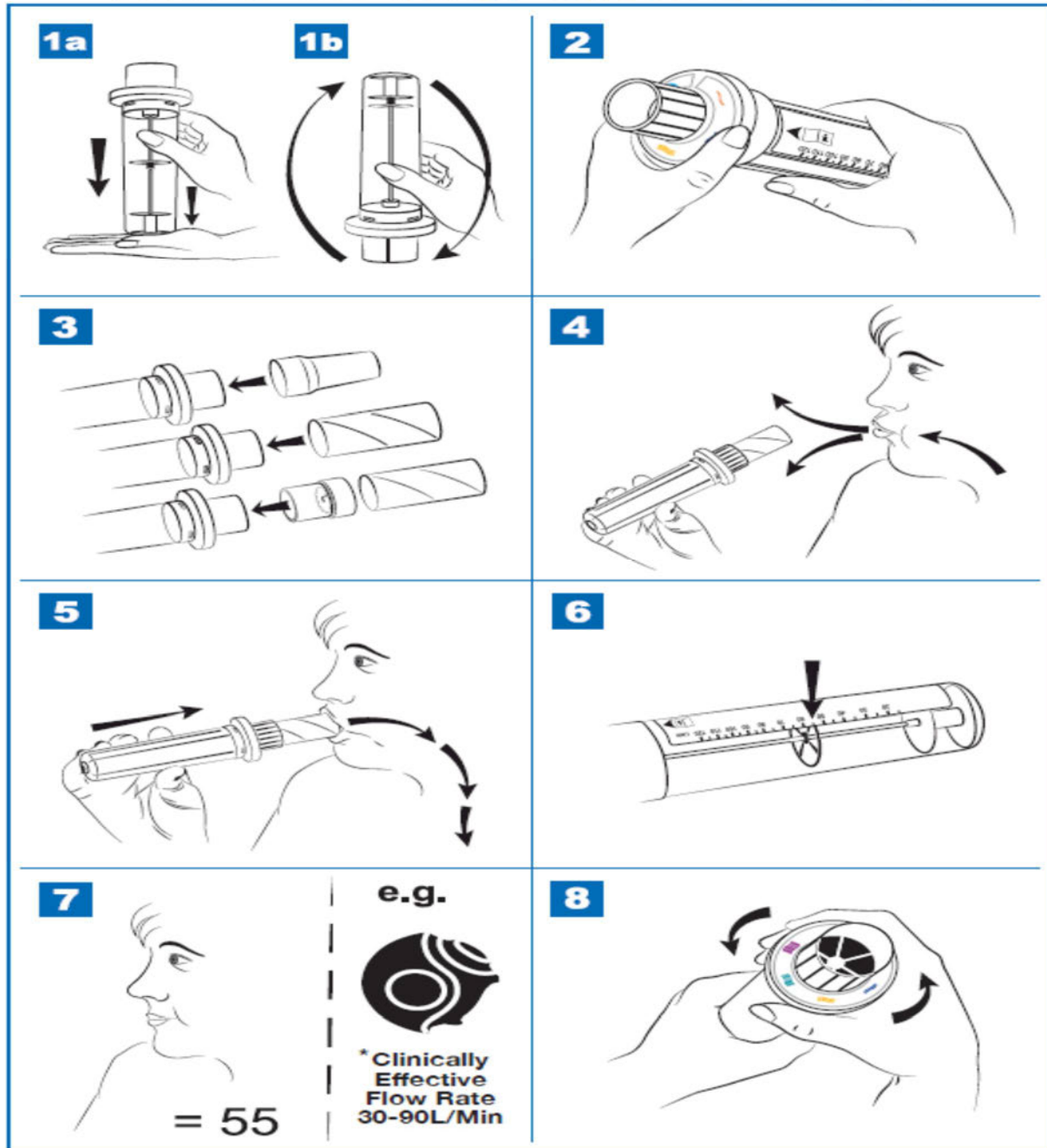

Instructions for Use

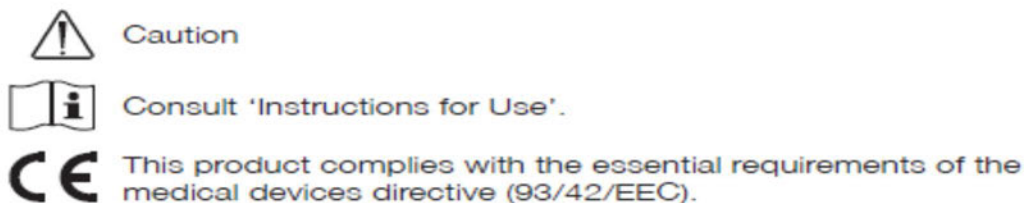

Introduction

The ***In-Check DIAL G16*** is an inhalation airflow training meter that can help educate and assess patients who use inhaler devices.

Inhaler devices are designed to deliver medication to the respiratory tract, and the speed of inhalation through them (the inspiratory flow) can have a significant effect on the quantity of drug delivered and the clinical efficacy of the product.

The ***In-Check DIAL G16*** is designed to simulate the "internal resistance" of common inhaler devices, and measure inspiratory flow. These measurements enable the healthcare professional to encourage patients to modify their inspiratory technique (by inhaling with more, or less effort), in order to achieve a flow rate consistent with clinical efficacy. The coloured 'flow' icons show the clinically effective flow ranges for each different inhaler device. These 'flow' icons do not imply any comparison between devices.

Patients that cannot achieve the suggested inspiratory flow for their inhaler may not gain maximum benefit from their prescribed medication, and healthcare professionals may wish to take this factor into account when selecting with the patient, the device that is the most suitable.

Inspiratory Flow and Clinically Effective Flow Range

The inspiratory flow through an inhaler is one of the factors that will influence the clinical effect of the drug delivery from that device. The most effective delivery occurs when the patient achieves a flow within the clinically effective flow range. Flow rates outside this range, may result in a diminished deposition and clinical efficacy.

Inhaler devices

Drug delivery from the various types of inhaler devices is produced by different methods.

Inhaler devices are designed to deliver drug particles of a certain size to the small airways during inhalation. Particles of this size (generally agreed to be approximately between 1 and 5 microns) are known as the "respirable dose". The particles are either in aerosol (in a suspension or a solution) or dry powder form.

Pressurised Metered Dose Inhalers (pMDIs)

With most pMDIs, the aerosol is delivered under pressure at high speed (often over 90 kilometres per hour). The inhalation should be timed with actuation of the device and should be slow and steady. Inhaling too fast may cause a greater proportion of the aerosol to impact at the back of the throat and be subsequently swallowed, thus reducing the beneficial clinical effect and increasing the potential for local and systemic side effects.

With the majority of pMDIs, manual depression of the drug canister actuates the drug delivery. However, with breath-actuated metered dose inhalers (e.g. Autohaler™), the aerosol is released by mechanical actuation, triggered by the patient breathing in through the device at any flow rate above a minimum level. At inspiratory flows below this, the patient will not receive any of the medication, because a dose will not be released.

pMDIs with Holding Chamber/Spacer

It is recognised that the optimum inhalation technique for using a pMDI with a holding chamber/spacer is a slow inhalation (30 to 60 L/min). As the resistances of the values of most chamber/spacer devices are low, the ***In-Check DIAL G16*** can be set to “conventional pMDI”  to provide an approximate resistance for inspiratory flow measurements to be made.

Dry Powder Inhalers (DPIs)

Drug delivery from DPIs is triggered by inhaling through the device. Turbulent airflows cause a metered quantity of powder to be drawn into the airflow, and follow a specific pathway within the inhaler, through internal features that create a resistance that is designed to break up the medication into particles of a respirable size.

As the internal design of each DPI is different, and the formulation of medication is not identical, the resistance the patient encounters when inhaling is different from device to device.

The effort required for the patient to achieve a given inspiratory flow will increase as the internal resistance of the device increases. For the same patient effort, the higher the resistance the lower the resulting inspiratory flow.

As the great majority of asthma medication is delivered via inhalers, correct inhaler technique is an important factor in the management of this disease. Patients require their medication for both short-term relief and long-term prevention, and the delivery of these drugs to the lungs is affected by inspiratory flow. Assessing inspiratory flow is an important aspect of device education and review. Determining whether or not a patient can obtain the appropriate inspiratory flow rate for a device can be an important factor in improving inhaled treatment.

In-Check DIAL G16

is a low-range inspiratory flow meter (15 to 120 L/min) that has a selectable resistance from high to low, shown by the coloured ‘flow’ icons on the back cover of this booklet, calibrated to enable the measurement of airflow as if the patient was using certain different inhalers.

The “conventional pMDI” position can be used to approximate the resistance when a conventional pMDI is attached to a holding chamber or spacer device.

In-Check DIAL G16 provides a measurement of inspiratory flow through five classes of device resistance. However, the resistance is not precise for all inhalers, e.g. the resistance of the Genuair is slightly lower than the resistance of the Turbohaler Mk III, but they are both medium resistance inhalers. To mimic the precise resistance of a particular inhaler, specific adaptors are available to use with the DIAL set to ‘conventional pMDI’.

Should new types of inhaler become available, then ***In-Check DIAL G16*** can be used to measure the new inspiratory flow, by knowing the resistance of the new inhaler.



IMPORTANT

As with any inhalation device, it is important to check for loose foreign objects before the device is used. The transparent material used in the construction of the **In-Check DIAL G16** enables the user to make a visual check before inhalation. Patients should be prevented from exhaling through the device prior to use.

To reset the In-Check DIAL G16

Hold the instrument vertically with the mouthpiece uppermost, so that the rounded end of the meter can be tapped against the other hand or a horizontal surface, such as a table.

A hard tap will dislodge the magnetic resetting weight, which will return the red cursor to a start position. When this has happened, the meter must turn through 180 degrees to return the magnetic weight to its resting position.



Do Not try to reset the **In-Check DIAL G16** as if it were a mercury thermometer

– this action causes serious damage to the piston and pointer.

How to use the In-Check DIAL G16 - see diagrams p1

1. Reset the **In-Check DIAL G16**. See above.
2. Align the dial selector with the desired coloured icon – an audible “click” should be heard.
3. Attach a clean mouthpiece. Disposable one-way inspiratory mouthpieces are preferred.
4. Ask the patient to exhale fully.
5. Ask the patient to seal their lips around the mouthpiece.
According to the inhaler chosen, instruct the patient to inhale in the manner recommended by the manufacturer.
6. Record the inspiratory flow from the position of the red cursor against the scale. Reset, and repeat two more times, ensuring correct technique each time.
7. Compare values achieved with target flows for that device. To operate an inhaler device correctly, the patient should be able to achieve a flow rate within the clinically effective range. *e.g. Accuhaler: Clinically Effective Flow Rate 30-90 L/Min.
8. If after repeated training the patient is not able to achieve these values, then the healthcare professional may wish to assess the patient’s ability to use an alternative type of inhaler.

Performance Accuracy

Accuracy +/- 10% or 10 L/min (whichever is the greater) and repeatability of +/- 5 L/min.

Cleaning your In-Check DIAL G16

Where local infection control guidelines exist, these should be respected. Immerse **In-Check DIAL G16** in warm (but not hot) mild detergent solution for 2-3 minutes (maximum 5 minutes). Agitate the meter to ensure thorough cleaning. Rinse in warm water and shake to remove any excess water. It is important to rinse thoroughly to prevent salt spots appearing on the inside of the body and the spindle.

To shake excess water from the **In-Check DIAL G16**, hold only at the end furthest away from the **DIAL** selector.

Allow to dry thoroughly before using again.

The expected life of the **In-Check DIAL G16**, in normal use, is two years.



To maintain hygiene the **In-Check DIAL G16** should be used with disposable inspiratory one-way mouthpieces. If use of this product is governed by local infection control guidance, that guidance should be respected.

Disposal Note: The **In-Check DIAL G16** can be disposed of as normal household waste.

Interpreting information from the In-Check DIAL G16

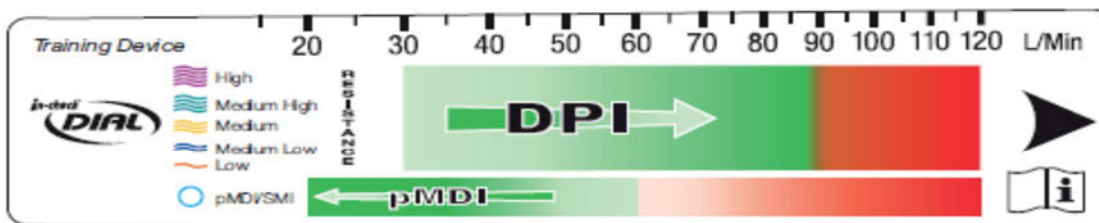

In-Check DIAL G16 was modified in January 2016, in response to customer feedback, to provide information about a wide range of new inhaler devices and the inspiratory flow rates that are associated with clinical efficacy. The new scale is shown above.

The information provided is for guidance only. It does not imply that any particular product will be clinically effective. There are other aspects than inspiratory flow that contribute towards clinical efficacy. The information is based on published clinical studies. In some cases studies may have been performed on a particular formulation in a specific device and may be suggestive that other formulations will behave similarly.

DPIs

Laboratory studies demonstrate that DPIs have a degree of flow-dependence, meaning that delivery may be affected by increasing flow rates. This does not always equate to improved clinical efficacy. A pale arrow represents the intention that flow rates of a higher level may be beneficial for DPIs.

pMDIs

The pMDIs have been represented in a single block from 20-60 L/Min because the clinical studies support this. The pale arrow is pointed in the opposite direction for pMDIs, indicating that a slower rather than higher flow rate is beneficial in this type of inhaler.

The devices are individually represented on the back cover.

Adaptors (specific device mimics)

These adaptors listed below can be used with the **In-Check DIAL G16** :

Turbohaler Mk II	- T	- 3109781
HandiHaler	- H	- 3109859
Diskhaler 4 Blister	- D4	- 3109788
Clickhaler	- C	- 3109786
Genuair	- G	- 3109861
Breezhaler	- B/F	- 3109783
Easyhaler (M) Monotherapy	- EH	- 3109787
Accuhaler	- A/A/D	- 3109822

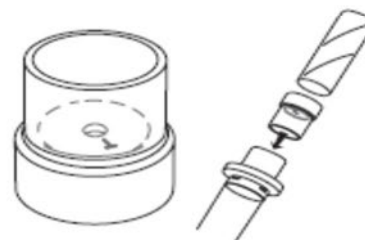

Set DIAL to the pMDI to use with device specific adaptor.



Inhaler Resistance Range

- High
- Med High
- Medium
- Med Low
- Low
- pMDI

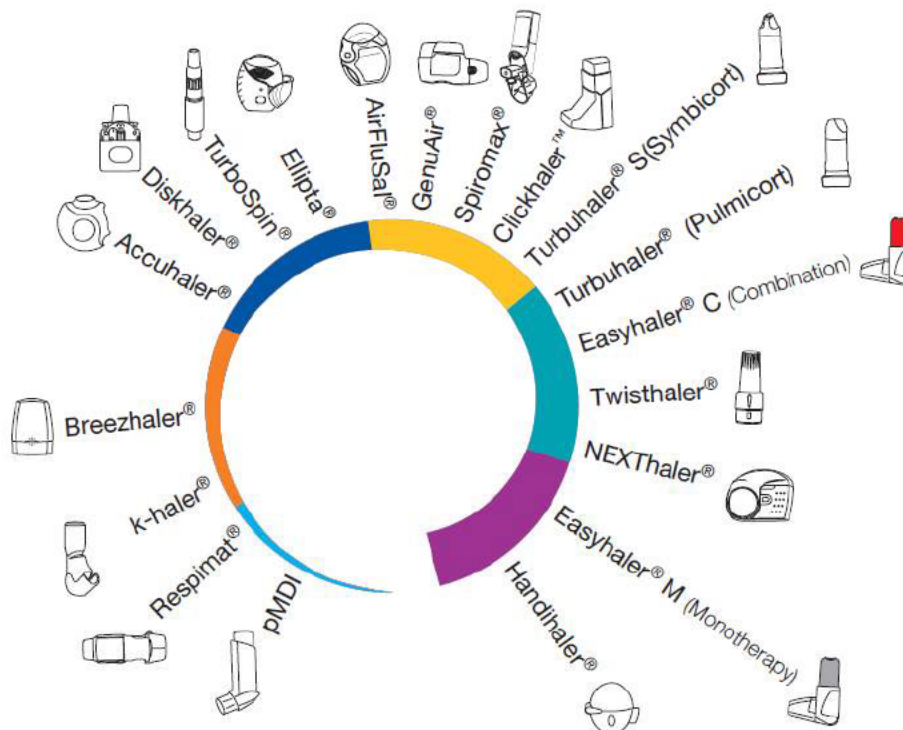

International

- Handihaler®
- Easyhaler®
- NEXThaler®
- Twisthaler®
- Turbuhaler®
- Turbuhaler®, Flexhaler®
- Clickhaler™
- RespiClick®, Spiromax®
- Novolizer®, Genuair®, Pressair®
- AirFluSal®
- Ellipta®
- TurboSpin®
- Diskhaler®
- Diskus®
- Breezhaler®, Aerolizer®, Neohaler®
- k-haler®
- Respimat®

Clement Clarke International Ltd.

















PPD [redacted] Harlow, Essex, CM20 2TT.

PPD [redacted]
 Web: www.clement-clarke.com

©Copyright 2016 Clement Clarke International Ltd.

Part no. 3109306 Issue no. 6 Jan 2019



Icon	Product	Icon	Product	Device Resistance
	*Handihaler®		AirFluSal®	
	*Easyhaler®		Ellipta®	
	NEXThaler®		TurboSpin®	
	Twisthaler®		*Diskhaler®(4)	
	*Turbuhaler® P		*Accuhaler®	
	Turbuhaler® S		*Breezhaler®	
	*Clickhaler™		k-haler®	
	Spiromax®		Respimat®	
	*GenuAir®			

Please Note:
 All trademarks and product names are the property of their respective owners, see IFU booklet for details.
 *Indicates device specific adaptor is available, see IFU booklet.

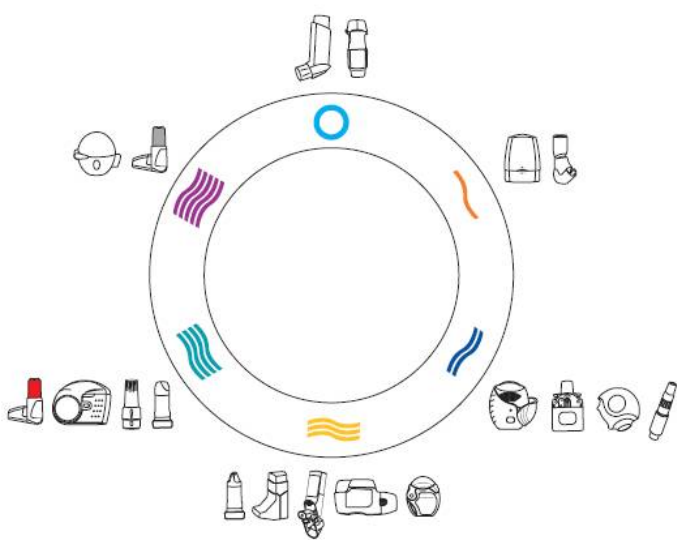

Assessing inspiratory flow rate for clinical efficacy:

Select appropriate resistance setting, inhale through meter, assess achieved flow rate.
 For DPIs values between 30-90 L/min are generally associated with clinical efficacy.
 For pMDIs values between 20-60 L/min are preferred.
 For Handihaler 20 L/min is associated with clinical efficacy.

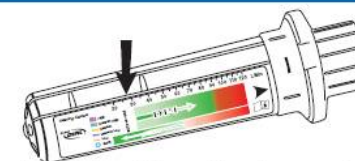

Bibliography:

1. Pedersen S, Dubus JC, Crompton G. 5) Inhaler selection in children with asthma. *Prim Care Respir J* 2010;**19** (3):209-16
2. Lavorini F, Levy ML, Corrigan C, Crompton G. 6) Training tools for inhalation devices. *Prim Care Respir J* 2010;**19** (4):335-41
3. Capstick, T. G., & Clifton, I. J. (2014). Inhaler technique and training in people with chronic obstructive pulmonary disease and asthma. *Expert review of respiratory medicine*.
4. Sanders, M. J. (2017). Guiding Inspiratory Flow: Development of the In-Check DIAL G16, a Tool for Improving Inhaler Technique. *Pulmonary medicine*, 2017.
5. Mahler, D. A. (2017). Peak inspiratory flow rate as a criterion for dry powder inhaler use in chronic obstructive pulmonary disease. *Annals of the American Thoracic Society*, 14(7), 1103-1107.
6. Laube, B. L., Janssens, H.M., de Jongh, F.H., Devadason, S.G., Dhand, R., Diot, P., ...& Chrystyn, H. (2011). What the pulmonary specialist should know about the new inhalation therapies. *European Respiratory Journal* **37** (6) 1308-1417.

Appendix K COPD Assessment Test

How is your COPD? Take the COPD Assessment Test™ (CAT)

This questionnaire will help you and your healthcare professional measure the impact COPD (Chronic Obstructive Pulmonary Disease) is having on your wellbeing and daily life. Your answers, and test score, can be used by you and your healthcare professional to help improve the management of your COPD and get the greatest benefit from treatment.

For each item below, place a mark (X) in the box that best describes you currently. Be sure to only select one response for each question.

Example: I am very happy (0) (1) (2) (3) (4) (5) I am very sad

		SCORE					
I never cough	(0) (1) (2) (3) (4) (5)	I cough all the time					
I have no phlegm (mucus) in my chest at all	(0) (1) (2) (3) (4) (5)	My chest is completely full of phlegm (mucus)					
My chest does not feel tight at all	(0) (1) (2) (3) (4) (5)	My chest feels very tight					
When I walk up a hill or one flight of stairs I am not breathless	(0) (1) (2) (3) (4) (5)	When I walk up a hill or one flight of stairs I am very breathless					
I am not limited doing any activities at home	(0) (1) (2) (3) (4) (5)	I am very limited doing activities at home					
I am confident leaving my home despite my lung condition	(0) (1) (2) (3) (4) (5)	I am not at all confident leaving my home because of my lung condition					
I sleep soundly	(0) (1) (2) (3) (4) (5)	I don't sleep soundly because of my lung condition					
I have lots of energy	(0) (1) (2) (3) (4) (5)	I have no energy at all					
							TOTAL SCORE

COPD Assessment Test and the CAT logo is a trade mark of the GlaxoSmithKline group of companies.
 © 2009 GlaxoSmithKline group of companies. All rights reserved.
 Last Updated: February 24, 2012

Appendix L Adverse Event Definitions and Additional Safety Information

L 1 Definition of adverse events

An adverse event is the development of any untoward medical occurrence in a subject or clinical study subject administered a medicinal product and which does not necessarily have a causal relationship with this treatment. An AE can therefore be any unfavourable and unintended sign (e.g. an abnormal laboratory finding), symptom (for example nausea, chest pain), or disease temporally associated with the use of a medicinal product, whether or not considered related to the medicinal product.

The term AE is used to include both serious and non-serious AEs and can include a deterioration of a pre-existing medical occurrence. An AE may occur at any time, including run-in or washout periods, even if no Study treatment has been administered.

L 2 Definitions of serious adverse event

A serious adverse event is an AE occurring during any study phase (i.e., run-in, treatment, washout, follow-up), that fulfils one or more of the following criteria:

- Results in death
- Is immediately life-threatening
- Requires in-subject hospitalisation or prolongation of existing hospitalisation
- Results in persistent or significant disability or incapacity.
- Is a congenital abnormality or birth defect
- Is an important medical event that may jeopardise the subject or may require medical treatment to prevent one of the outcomes listed above.

L 3 Life threatening

‘Life-threatening’ means that the subject was at immediate risk of death from the AE as it occurred, or it is suspected that use or continued use of the product would result in the subject’s death. ‘Life-threatening’ does not mean that had an AE occurred in a more severe form it might have caused death (e.g., hepatitis that resolved without hepatic failure).

L 4 Hospitalization

Outpatient treatment in an emergency room is not in itself a serious AE, although the reasons for it may be (e.g., bronchospasm, laryngeal oedema). Hospital admissions and/or surgical operations planned before or during a study are not considered AEs if the illness or disease existed before the subject was enrolled in the study, provided that it did not deteriorate in an unexpected way during the study.

L 5 Important medical event or medical treatment

Medical and scientific judgement should be exercised in deciding whether a case is serious in situations where important medical events may not be immediately life threatening or result in death, hospitalisation, disability or incapacity but may jeopardize the subject or may require medical treatment to prevent one or more outcomes listed in the definition of serious. These should usually be considered as serious.

Simply stopping the suspect drug does not mean that it is an important medical event; medical judgement must be used.

- Angioedema not severe enough to require intubation but requiring iv hydrocortisone treatment
- Hepatotoxicity caused by paracetamol (acetaminophen) overdose requiring treatment with N-acetylcysteine
- Intensive treatment in an emergency room or at home for allergic bronchospasm
- Blood dyscrasias (e.g., neutropenia or anaemia requiring blood transfusion, etc.) or convulsions that do not result in hospitalisation
- Development of drug dependency or drug abuse

L 6 Intensity rating scale:

- mild (awareness of sign or symptom, but easily tolerated)
- moderate (discomfort sufficient to cause interference with normal activities)
- severe (incapacitating, with inability to perform normal activities)

It is important to distinguish between serious and severe AEs. Severity is a measure of intensity whereas seriousness is defined by the criteria in Appendix L 2. An AE of severe intensity need not necessarily be considered serious. For example, nausea that persists for several hours may be considered severe nausea, but not a SAE unless it meets the criteria shown in Appendix L 2. On the other hand, a stroke that results in only a limited degree of disability may be considered a mild stroke but would be a SAE when it satisfies the criteria shown in Appendix L 2.

L 7 A Guide to Interpreting the Causality Question

When making an assessment of causality consider the following factors when deciding if there is a ‘reasonable possibility’ that an AE may have been caused by the drug.

- Time Course. Exposure to suspect drug. Has the subject actually received the suspect drug? Did the AE occur in a reasonable temporal relationship to the administration of the suspect drug?
- Consistency with known drug profile. Was the AE consistent with the previous knowledge of the suspect drug (pharmacology and toxicology) or drugs of the same

pharmacological class? Or could the AE be anticipated from its pharmacological properties?

- De-challenge experience. Did the AE resolve or improve on stopping or reducing the dose of the suspect drug?
- No alternative cause. The AE cannot be reasonably explained by another aetiology such as the underlying disease, other drugs, other host or environmental factors.
- Re-challenge experience. Did the AE reoccur if the suspected drug was reintroduced after having been stopped? AstraZeneca would not normally recommend or support a re-challenge.
- Laboratory tests. A specific laboratory investigation (if performed) has confirmed the relationship.

In difficult cases, other factors could be considered such as:

- Is this a recognized feature of overdose of the drug?
- Is there a known mechanism?

Causality of ‘related’ is made if following a review of the relevant data, there is evidence for a ‘reasonable possibility’ of a causal relationship for the individual case. The expression ‘reasonable possibility’ of a causal relationship is meant to convey, in general, that there are facts (evidence) or arguments to suggest a causal relationship.

The causality assessment is performed based on the available data including enough information to make an informed judgment. With limited or insufficient information in the case, it is likely that the event(s) will be assessed as ‘not related’.

Causal relationship in cases where the disease under study has deteriorated due to lack of effect should be classified as no reasonable possibility.

L 8 Medication Error

For the purposes of this clinical study a medication error is an unintended failure or mistake in the treatment process for an AstraZeneca study drug that either causes harm to the participant or has the potential to cause harm to the participant.

A medication error is not lack of efficacy of the drug, but rather a human or process related failure while the drug is in control of the study site staff or participant.

Medication error includes situations where an error.

- occurred
- was identified and intercepted before the participant received the drug
- did not occur, but circumstances were recognized that could have led to an error

Examples of events to be reported in clinical studies as medication errors:

- Drug name confusion
- Dispensing error e.g. medication prepared incorrectly, even if it was not actually given to the participant
- Drug not administered as indicated, for example, wrong route or wrong site of administration
- Drug not taken as indicated e.g. tablet dissolved in water when it should be taken as a solid tablet
- Drug not stored as instructed e.g. kept in the fridge when it should be at room temperature
- Wrong participant received the medication (excluding IWRS errors)
- Wrong drug administered to participant (excluding IWRS errors)

Examples of events that **do not** require reporting as medication errors in clinical studies:

- Errors related to or resulting from IWRS - including those which lead to one of the above listed events that would otherwise have been a medication error
- Participant accidentally missed drug dose(s) e.g. forgot to take medication
- Accidental overdose (will be captured as an overdose)
- Participant failed to return unused medication or empty packaging
- Errors related to background and rescue medication, or standard of care medication in open label studies, even if an AstraZeneca product

Medication errors are not regarded as AEs but AEs may occur as a consequence of the medication error.

Appendix M Study Instructions for Mitigation Due to Civil Crisis, Natural Disaster, or Public Health Crisis

To ensure clinical trial continuity in the case of study disruption due to civil crisis, natural disaster, or public health crisis, changes may be implemented in order to ensure the safety of trial participants, maintain compliance with good clinical practice (GCP), and minimize risks to trial integrity. Where allowable by local health authorities, ethics committees and healthcare provider guidelines (eg, hospital policies), these changes may include the following but is not limited to:

- Obtaining consent/reconsent for the mitigation procedures (note, in the case of verbal consent/reconsent, the informed consent form (ICF) should be signed at the participant's next contact with the study site). Prior to informed consent form, local study institution or HA guidelines should be followed as appropriate.
- Rescreening: Additional rescreening for screen failure and to confirm eligibility to participate in the clinical study can be performed in previously screened participants. The investigator should confirm this with the designated study physician. Please refer to Section 5.5 for additional information.

1. COMMUNICATION BETWEEN SITES AND PARTICIPANTS

All communication between sites and participants should be in line with local and regional guidelines and captured in the study source documents. In the event of a crisis, the study team will outline the planned communication strategy in an email to the site. Communication should be compliant with all applicable privacy regulations. Methods of written communication may include clinic/participant, participant portals, direct email, or secure mail if other methods are not available. Staff must ensure that communications adhere to guidelines for the transfer and storage of data on digital channels. The guidelines include details about the use of data, encryption, servers, authentication, and audit trails. These standards are the responsibility of both the vendor and the health provider.

2. RESCREENING OF PARTICIPANTS TO RECONFIRM STUDY ELIGIBILITY

2.1. Rescreening of Participants Who Were Previously Screen Failures Due to Study Disruption

A participant who failed screening due to study disruption may be rescreened in addition to any rescreening rules designated in the CSP. The investigator should confirm this with the designated study physician.

Screening procedures as designated in the CSP Section 5.5 should be followed.

2.2. Rescreening of Participants Who Were Previously Eligible for Entry into the Study but Not Dosed Due to Study Disruption

During study disruption there may be a delay between confirming eligibility of a participants and either randomisation into the study or commencing of dosing with IP. If this delay is outside the screening window, the participants will need to be rescreened to reconfirm eligibility before commencing study procedures. This will provide another opportunity to re-screen a participant to any rescreening rules designated in the CSP.

Screening procedures as designated in the CSP Section [5.5](#) should be followed.

Appendix N Abbreviations

Abbreviation or special term	Explanation
AE	adverse event
ALT	alanine aminotransferase
ANCOVA	analysis of covariance
AST	aspartate aminotransferase
ATS	American Thoracic Society
AUC ₀₋₄	area under the curve 0 to 4 hours
AUC ₀₋₄	Area under the concentration-time curve from 0 to 4-hours post-dose
BFF	budesonide and formoterol fumarate
BID	twice daily
CAT	COPD Assessment Test
CFR	Code of Federal Regulation
CI	confidence interval
CIOMS	Council for International Organizations of Medical Sciences
C _{max}	maximum observed plasma concentration
C _{trough}	the concentration at the end of the dosing interval
CONSORT	Consolidated Standards of Reporting Trials
COPD	chronic obstructive pulmonary disease
CPK-EPI	Chronic Kidney Disease Epidemiology Collaboration
CV%	coefficient of variation
DPI	dry powder inhaler
ECG	Electrocardiogram
eCRF	electronic case report form
ERS	European Respiratory Society
EV	extrapolated volume
FEV ₁	forced expiratory volume in 1 second
FVC	forced vital capacity
GCP	Good Clinical Practice
GMP	Good Manufacturing Practice
GOLD	Global Initiative for Chronic Obstructive Lung Disease
HFA	Hydrofluoroalkane
HIPAA	Health Insurance Portability and Accountability Act

Abbreviation or special term	Explanation
IC	inspiratory capacity
ICF	informed consent form
ICH	International Conference on Harmonisation
ICS	inhaled corticosteroid
IEC	Independent Ethics Committee
IP	investigational product
IRB	Institutional Review Board
ITT	Intent-to-Treat
IWRS	interactive web response system
LABA	long-acting beta ₂ -agonist
MDI	metered dose inhaler
MedDRA	Medical Dictionary for Regulatory Activities
mITT	modified Intent-to-Treat
PEF	peak expiratory flow
PFT	pulmonary function test
PIF	peak inspiratory flow
PIN	personal identification number
PK	Pharmacokinetics
QID	four times a day
QTcF	QT interval corrected for heart rate using Fridericia's formula
SAE	serious adverse event
SABA	short-acting beta ₂ -agonist
SAMA	short-acting muscarinic antagonist
SoA	Schedule of Activities
t _{max}	time to maximum observed peak concentration
VHC	valve holding chamber

SIGNATURE PAGE

This is a representation of an electronic record that was signed electronically and this page is the manifestation of the electronic signature

Document Name: d5980c00023-csp-v4		
Document Title:	D5980C00023 Clinical Study Protocol version 4	
Document ID:	Doc ID-003998775	
Version Label:	5.0 CURRENT LATEST APPROVED	
Server Date (dd-MMM-yyyy HH:mm 'UTC'Z)	Signed by	Meaning of Signature
CCI [REDACTED] 14:50 UTC	PPD [REDACTED]	Content Approval
CCI [REDACTED] 14:28 UTC	PPD [REDACTED]	Management Approval
CCI [REDACTED] 13:41 UTC	PPD [REDACTED]	Content Approval
CCI [REDACTED] 14:01 UTC	PPD [REDACTED]	Content Approval
CCI [REDACTED] 13:40 UTC	PPD [REDACTED] PPD [REDACTED]	Content Approval

Notes: (1) Document details as stored in ANGEL, an AstraZeneca document management system.